

Index	Page
Important Hints	3
Operating instructions transport case	4
1. Instrument Design	7
2. Gas Cooler (option)	9
3. Power Supply	10
4. Data Memory	10
5. Instrument Start	11
6. Input or Selection of combustion plants	13
7. Flue Gas Analysis	
7.1. Gas analysis	16
7.2. CO measurement (gas path check)	19
7.3. O ₂ check	20
7.4. Draught measurement	20
7.5. Flow measurement (option)	21
7.6. Biogas measurement (option)	22
7.7. Soot dot...Oil trace	23
7.8. Measurement record and printout	24
7.9. After Measurement	26
8. Mean Value Measurement	27
9. Adjustments	29
10. Control	33
11. Data Processing	
11.1 Communication	34
11.2. Data logger	35
11.3. Data logging with DASNT2	36
11.4. Data processing with DAS5	36
11.5. Data processing with App	37
12. Diagnostics	
12.1. Fault diagnostic	38
12.2. delta-T measurement	40
12.3. Heating check (option)	40
12.4. 4 Pa measurement (option)	44
12.5. Pressure Tests (option)	45
13. Maintenance Tips	52
14. Technical Data	56
15. FAQ	57

Congratulations!

With your purchase you have decided on a high-quality product of ecom GmbH.

Get to know the product before you start using it while reading carefully the following instructions of use and the safety indications. Use the product only as described and only for the given areas of application in order to ascertain its longevity.

Important Hints



The ecom-D meets the requirements of the DIN EN 50379 Part 2.



The ecom-D should not be used for continuous emission control!



Observe the following minimum times in order to get correct measurement values:

- 1 min. for sensors calibration at fresh air
- 2 min. for stable measurement values



The following substances impair the instrument's operation:

- Solvent-containing vapours as:
 - cleaning agents
 - degreasers
 - wax polishes
 - adhesives

do contain

- Formaldehyde



Adjustments at burners and boilers should be made only by specialists who are familiar with these installations.



- 1. Charge the internal accumulator regularly.**
(an unused analyser should be charged at least 1 x per month)!
- 2. Never store the unit with a discharged battery!**

Fresh air opening

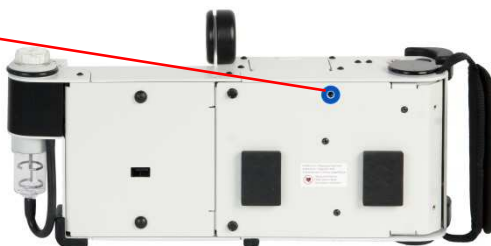

Do not lock fresh air opening for fresh air pump!

Operating instructions transport case

The ecom-D can be operated in the **hard-shell transport case**. Before starting measurements the instrument must be set-up as follows:

- Pull **unlock**
- Raise instrument as far as it goes
- Unlocking pin must engage



Unlock



The ecom-D is attached with magnets to the **holder**. To remove the instrument, please proceed as follows:

- Keep **holder** with left hand
- Hold **eyelet** with right hand
- Remove instrument from the **holder** by pulling

When putting back the instrument in the **holder**, it must be set with the two holes on the bottom in the **bolts** of the **holder**.

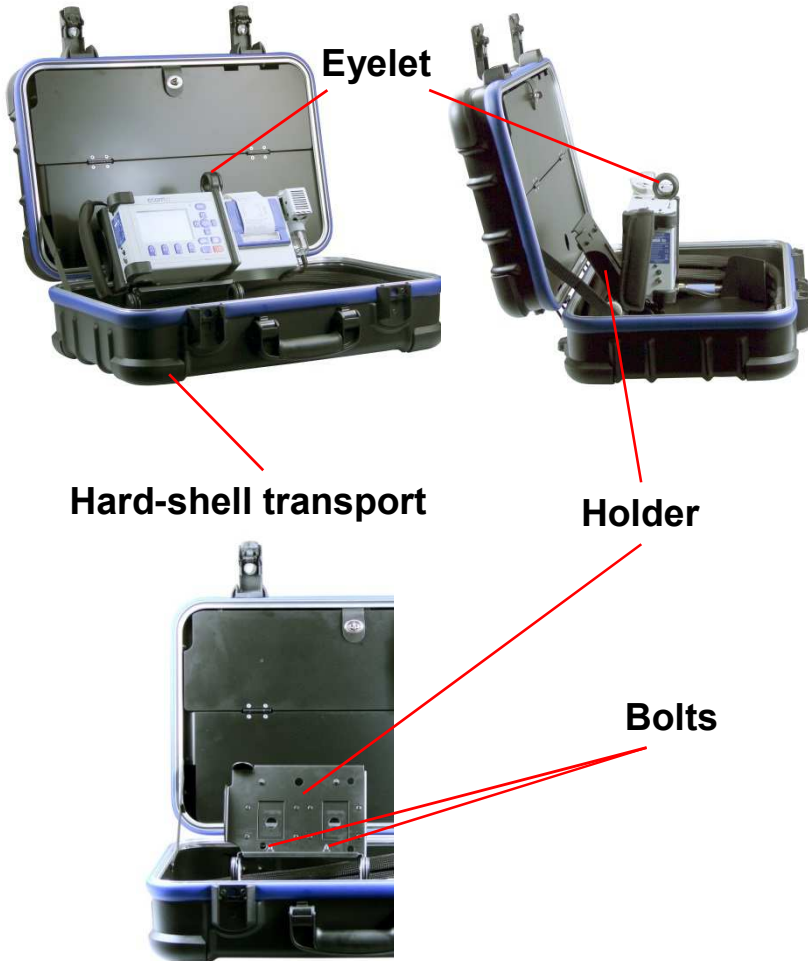

1. Instrument Design

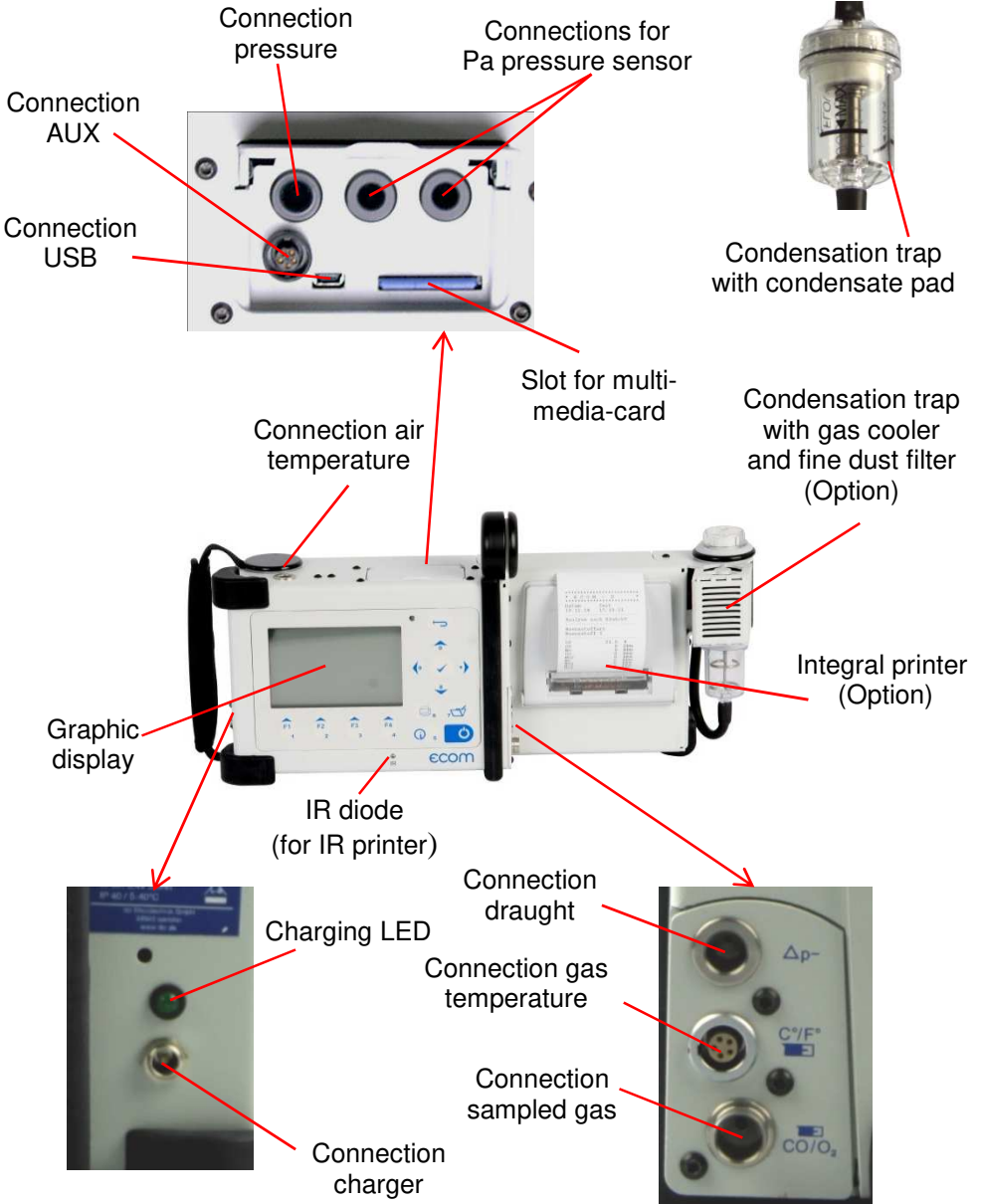

Keyboard

In the input mode, the keys are used for numerical inputs

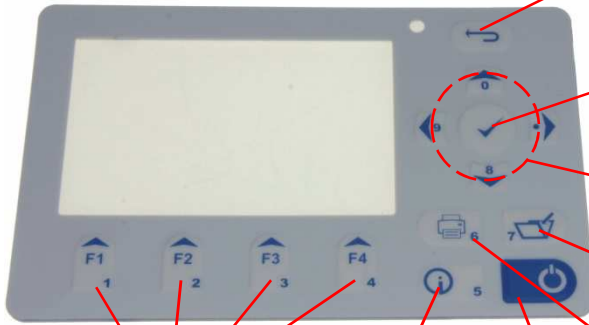

ESC key
(quit/
exit menu)

Enter key
(confirm
selection)

Cursor keys
(Up/Down/Right/
Left/Scroll)

Values
recording

Function keys
(function shown on
display)

Info key
(access to
control menu)

ON / OFF
key

Print key
(access to
printing menu)

2. Gas Cooler (option)

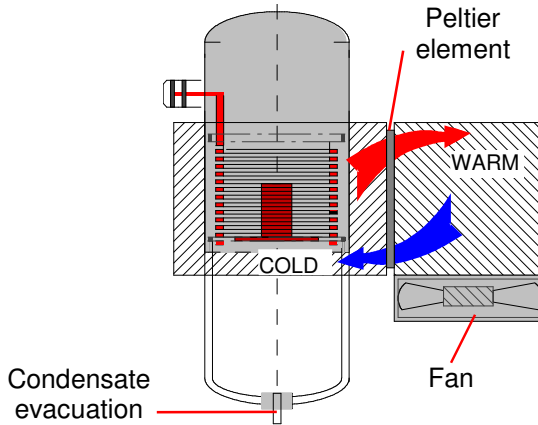

Exhaust gas with a temperature over the steam dew point (35 - 65 °C) is flown spiral via a long gas path thru a surface coated metal body with good thermal conductivity. The gas radiates its heat to this metal body. A Peltier element (semi-conductor cooling element) flown by a continuous current is thermal connected with this body and with a second metal body with cooling ribs and ventilation slots.

The flow thru the Peltier element creates a heat transfer from **WARM** to **COLD**, drains the heat of the metal body flown by gas and conveys it to the outer cooling body. This heat is conveyed thru a vertical forced ventilation to the surrounding air.

The condensation issued by the heat loss of the gas drops in a receptacle.

By accumulator operation, the Peltier cooler can be switched off.

In the measurement menu press hereto **<Enter>**, select the menu point „**Peltier I/O**“ and press again **<Enter>** (for Peltier cooler switch on, just repeat this procedure).

3. Power Supply



Used accumulators can either be returned to us or brought to recycling stations of public waste disposal companies respectively to stores selling accumulators!

The ecom-D comes with an external charger. The analyser can also be powered via the internal accumulator for a while (6 V; 3.8 Ah). The accumulator recharge should be started when the instrument requires to (acoustical warning and display indication). The accumulator charging stand can be checked looking at the voltage indication on the display (menu "**Control**" - Info key). The battery warning is activated when the value „Accu“ is smaller than 5.9 V.

By 5.8 V the power operation via battery is no more possible; the instrument must be further powered via the external charger.

4. Data Memory

The multi-media card enables the storage of punctual measurements; the gathered values are written in a text file (J2KDV.txt). Data format information is to be found in the appendix. The files can be transferred to a PC via a card reader.

The following conditions must be fulfilled for using a multi-media card:

- min. card volume 32 MB - max.32 GB (UHC)
- card formatted on 16 bit FAT or FAT32
- SD cards from SanDisk recommended
- PC with card reader

Card insert

Insert the multi-media-card as shown. Take care that the card does not stand out and that it well hooks on.



**Never pull out cards during data record
- data loss and damaging of the
multi-media-card are possible!**

5. Instrument Start



**Always position the probe in the exhaust pipe once
the calibration phase is over!**



**Always use a filtering system as per our recommenda-
tion for combustion plants
firing solid combustibles!**

Once the instrument is switched on (key <I/O>), the main menu is displayed. 6 sub-menus with the following functions (non-visible sub-menus can be called up while scrolling with the cursor keys) are displayed:

Gas analysis
Soot..Oil trace
Data processing
Adjustments
Control
Diagnostics

- Gas analysis : Perform gas analysis
- Soot...Oil trace : Input of soot measurement results
- Data processing : Assign measurements / Data transfer (only with inserted multi-media-card)
- Adjustments : Modify instrument settings
- Control : Check operation state of instrument
- Diagnostics : Read-out of firing automate (only in connection with ecom-AK) / delta-T measurement / Heating check / 4 Pa test

To perform measurements, select with the cursor keys the sub-menu "**Gas analysis**" and confirm with **<Enter>**. The instrument starts a 1- minute calibration phase and it enquires if you wish to use the data bank. If you want to assign the sampled data to a specific plant, so press **<F1>** (**<F4>** = no: measurement will be performed without assignment).

Do you wish to use the data processing?	
Select: <input type="checkbox"/> <input checked="" type="checkbox"/>	
<input type="checkbox"/> YES	<input checked="" type="checkbox"/> NO

Fuel types acc. to 1st BImSchV

Fuel oil (B)

Natural gas (B)

City gas (B)

Coke oven gas (B)

Liquid gas (B)

Use the cursor keys to select the desired fuel type and confirm with **<Enter>**.

Fuel type		
Fuel oil (B)		
CO2max	A1	B
15.4	0.50	0.007
Select: <input checked="" type="checkbox"/> <input checked="" type="checkbox"/>		

6. Input or selection of combustion plants

To call up plant data already recorded or to create a new file, the following possibilities are available:

Create new (is automatically selected by first use of a MM card): To create a new file, a numerical number should be assigned.

Select „**Create new**“ and confirm with **<Enter>**. Input a random number (max. 16 figures) using the keyboard:

- use the cursor keys **<Up/Down/Right/Left>** to select the figure (selected figure outlined by a black background)
- press **<Enter>** to accept the figure (press **<F2>** to delete the last figure if needed)
- repeat this procedure until the desired number is complete.

Selection upon:
Search word
Memory number
Create new
Quit with: 

Example: "25.09.2014"

Tip: We suggest a date-related input to easily find the data record later on via the search function.

After confirming with **<F1>** it is possible to enter a text via the keyboard (max. 6 lines with 20 characters each) which is printed out and can be used for data processing purposes. Proceed as follows:

- select text line 1 using the cursor keys **<Up/Down>** and confirm with **<Enter>**
- select with **<F3>** the keyboard mode (4 keyboard modes are available)
- select with the cursor keys **<Up/Down/Right/Left>** the desired character (selected character outlined by a black background)
- press **<Enter>** to accept the character (press **<F2>** to delete the last character)
- repeat this procedure until the desired text is complete.

- proceed as follows to correct a character:
 - press **<F4>** to interrupt the character selection
 - use the cursor keys **<Right/Left>** to select the character requiring correction
 - activate with **<F4>** the character selection and correct character
- return with **<F1>** to character selection and call up next line for process

The input is closed with **<ESC>** and the next available data record is activated. Press **<ESC>** to return to the gas analysis menu.

Memory number: For check of the plant already stored in the instrument, the selection upon record number is most appropriate.

Select „**Memory number**“ and confirm with **<Enter>**. Input a random data record number:

Example: "3" for data record number 3

Selection upon:
Search word
Memory number
Create new
Quit with: 

Input number
<input style="width: 100px; height: 20px;" type="text" value="3"/>
Please use the numerical keys!

- Press **<Enter>** once the input is completed to call up said data record number. The cursor keys **<Up/Down>** enable the check of the record numbers.
- Press **<F1>** to select the first record number and **<F2>** for the last.
- Press **<F4>** to delete the content of the selected record number.
- Press **<Enter>** to activate the record number.
- Finally press **<ESC>** to start the gas analysis.

Search word: If the plant code is known, it is possible to find the plant data stored with help of a search machine. Select hereto **"Search word"** and confirm with **<Enter>**. Using the software keyboard, input at least 3 connected figures of the plant:

Example: "25.09" for plant code 25.09.2014

After input completion, press **<F1>** to start the search. All files matching this code will be filtered. The resulting selection can be scrolled using the cursor keys (F1 for selection start, F2 for selection end). Once found, activate the desired data record with **<Enter>**. The last measurement on this plant can be viewed pressing **<Enter>** / „**View memory**“ / **<Enter>**. All measured and calculated values can be called up on 5 display pages, using the cursor keys to step thru.

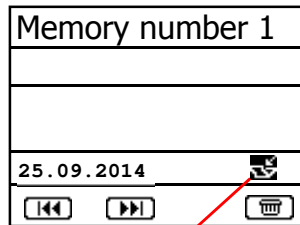

Measurement available

<p>Memory number 1</p> <hr/> <p>25.09.2014</p> <p>12:15 25.09.14</p>	<p>O2 3.2 % CO2 13.1 % CO 0 ppm Eff. 92.5 % Losses 7.5 % Exc. air 1.18 T.Gas 184 °C T.Air 20 °C</p> <p>Gas analysis 12:15 25.09.14 Memory number 1</p>	<p>O2 17.5 % CO 0% 738 ppm CO 123 ppm Exc. air 7.00</p> <p>CO measurement 12:15 25.09.14 Memory number 1</p>
<p>O2 value in air</p> <p>o2 19.5 % co 3 ppm Draught 0.01 hPa</p> <p>O2 value in air 12:15 25.09.14 Memory number 1</p>	<p>Soot..Oil trace</p> <p>Boiler temp. : 65°C 1.Soot meas. : 0.5 2.Soot meas. : 0.3 3.Soot meas. : 0.7 Oil trace : NEIN</p> <p>Soot..Oil trace 12:15 25.09.14 Memory number 1</p>	<p>dT-measurement</p> <p>T1 70.4 °C T2 56.3 °C dT 14.1 °C</p> <p>dT-measurement 12:15 25.09.14 Memory number 1</p>

Press **<ESC>** to escape the previous measurement data and the recording of the current data can start.

7. Flue Gas Analysis

7.1. Gas analysis



Re-calibrate the instrument after each measurement (after one hour at the latest) to keep the accuracy of the results!

After the 1-minute calibration phase, the instrument switches over to the measurement mode. The gas measurement values can be viewed on 4 display pages. Use the cursor keys to scroll the pages.

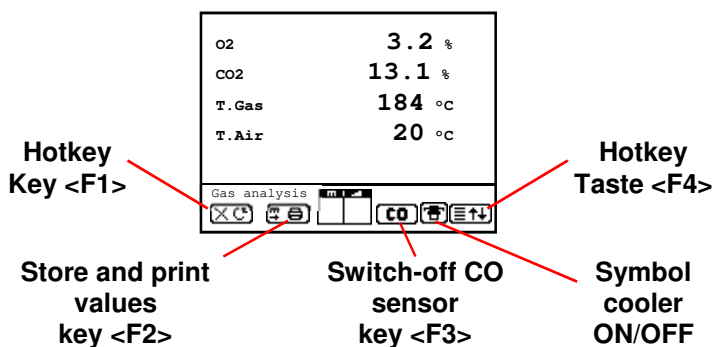

Pressing <F1> enables to switch, from the values display, to a menu point selected before or on „Standby“ (see chapter Adjustments). Possible menu points are: Soot...Oil trace, Data processing, View memory, Display values, Fuel type, Efficiency (K), Internal, Adjustments. Furthermore you can switch back from any random menu point to the values display with <F1>.

Press <F2> to print out the values simultaneously to their recording in the intermediate memory.

Press <F3> to cut the CO sensor from the gas path so that it is protected against too high concentrations.

Pressing <F4> also enables to switch, from the values display, to a menu point selected before or on „Standby“ (see chapter Adjustments). Possible menu points are: Soot...Oil trace, Data processing, View memory, Display values, Fuel type, Efficiency (K), Internal, Adjustments (back to values display with <F1>).

The position of the measured and calculated values (gas analysis sub-menu) on the display pages is free selectable. For alteration of the existing succession, proceed as follows:

- Press **<Enter>** / „**Display values**“ / **<Enter>** to activate the function
 - select line with cursor keys (Up/Down)
 - select desired parameter with cursor keys (Right/Left)
 - repeat procedure until desired layout is completed
- Press **<Enter>** to deactivate the function

O2	3.2 %
CO2	13.1 %
CO	0 ppm
Eff.	92.5 %
Losses	7.5 %
Exc. air	1.18
T.Gas	184 °C
T.Air	20 °C

Gas analysis	

Core stream search

Connect the sampling tubing on the instrument to the plug „Connection gas“. Position the sampling probe in the exhaust channel, so that the thermocouple is fully surrounded with the gas (see drawing).

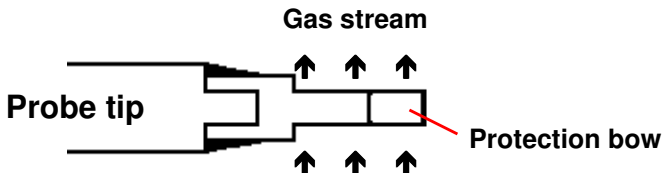

Perform the measurement in the core stream of the exhaust gas channel (probe placed in the hottest gas temperature area). A trend indication for T.Gas eases the core stream search. As long as the display shows an arrow in upwards direction, the measured temperature increases, it means the probe tip moves towards the core stream center. If an arrow in downwards direction is displayed, it means you move the probe away from the core stream and the temperature sinks. If no temperature change is shown for at least 3 seconds, so the trend indication will disappear.

CO₂, efficiency, losses, excess air and dew point are calculated values. They can only be calculated if realistic values for the basic parameters like O₂ and the temperatures are available. It must be ascertained that:

$$O_2 < 20,5 \% \text{ and } T.Gas - T.Air > + 5 \text{ }^\circ\text{C}$$

are given. The dew point can only be calculated accurately if, in the menu "**Adjustments**", the current barometric air pressure value has been entered. If the gas temperature falls below the dew point (between 25 and 65 °C), so efficiency will be calculated with condensation gain. In this case a (K) is displayed after „Efficiency“.

Correct measurement values are displayed first after a short delay, necessary for the gas transport and the build-up of a stable electrochemical reaction to the sensors. This time period lasts approx. 1 to 1.5 minute. For recording, printout and evaluation, wait until the values do not change anymore. If deviations higher than 2 ppm still occur by the gas values, they can be due to unstable pressure conditions in the exhaust channel.

If the measurement values are stable and the results can be printed out, press the key **<Record>** (disk symbol) to transfer the values in the intermediate memory (caution: store separately gas analysis, CO, O₂ check and draught measurements). They will be kept there for a later printout and, if need be, for a final data record storage.

O2	3.2 %
CO2	13.1 %
CO	0 ppm
Eff.	92.5 %
Losses	7.5 %
Exc. air	1.18
T.Gas	184 °C
T.Air	20 °C

Gas analysis	

Measurement stored in intermediate memory

If a printout of the values should be made simultaneously to the intermediate recording, so press **<F2>** (the complete content of the intermediate memory will be printed).

The CO sensor is protected against overload thanks to an internal programme. If the 4000 ppm limit value is exceeded, so a purging pump is activated which provides the sensor with fresh air. After sufficient purging time (X behind CO disappears) the sensor can be reintegrated into the measurement system with <F3> (if you choose „Yes“ at „Adjustments“ / „Internal“ / „CO-Automatic“ the CO sensor switches to measurement automatically). The sensor can also be manually be excluded from the measurement system with <F3>.

7.2. CO Measurement (gas path check)

The gas channel check, called also CO measurement, is used for the technical check of gas-fired plants in regards of safety aspects. Hereby the CO concentration in the gas channel is measured after the flow safety device and calculated on an undiluted value (oxygen rest content in flue gas = 0%). As the gas conditions after the flow safety device are no more homogeneous because of the flow in of secondary air and consequently the core stream measurement can be erratic, the analysis of the exhaust gas is performed along the totality of the exhaust pipe diameter. A multi-hole probe (optional accessory) is hereby used as sampling probe.

The calculated value shown on the line „CO 0 %“ corresponds to the measured CO concentration supposed the oxygen content would amount 0% by the same exhaust gas volume. It is consequently the undiluted CO content in exhaust gas. If the values indication is stable, press <Record> to store the result in the intermediate memory. If a printout of the values should occur simultaneously to the recording in the intermediate memory press <F2> (the complete content of the intermediate memory will be printed out).

O2	17.5 %
CO 0%	738 ppm
CO	123 ppm
Exc. air	7.00

CO-measurement	

Measurement stored in intermediate memory

7.3. O₂ check

This measurement is performed by ambient air independent plants like gross calorific value plants. It is determined if exhaust gas flows into the combustion air (O₂ content drops down / CO content can be present) and herewith influence on the combustion quality.

For this analysis, a special multi-hole probe (optional accessory) should be used. If the value indicated is stable, press **<Record>** to store the value in the intermediate memory. If a printout of the values should occur simultaneously to the recording in the intermediate memory, press **<F2>** (the complete content of the intermediate memory will be printed out).

O2 value in air	
O2	19.5 %
CO	3 ppm
Draught	0.01 hPa
O2 val. in air	

Measurement stored in intermediate memory

7.4. Draught Measurement

A trend indication for the draught conditions in the exhaust channel can already be viewed during the gas analysis. Nevertheless the value for the chimney draught will not be stored together with the gas values while pressing **<Record>** because the differential pressure sensor tends to drifts because of its sensibility.

For an exact measurement, it is consequently advised to re-calibrate this sensor just before sampling and documenting the value.

The display shows the current value as well as the recommendation to re-set the zero point of the sensor. Disconnect the draught hose from the instrument for a short moment and press **<F4>**. The sensor is herewith re-calibrated.

Pressure
-0.12 hPa
Recorded value: ---.--- hPa

Re-connect the draught tubing. The display shows the exact measurement value which can be stored while pressing **<Record>** and added to those results previous stored in the intermediate memory. The recorded value is shown on the display.

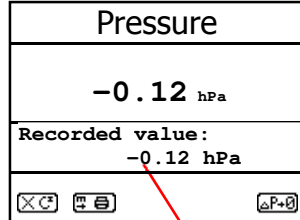

Measurement stored in intermediate memory

7.5. Flow measurement (option)

This measurement can be done with a pitot tube. At first the pitot factor of the pitot tube must be entered („**Adjustments**“ / „**Internal**“ / „**Pitot factor**“). After connecting the pitot tube to the instrument, the zero point of the sensor can be set with **<F4>**. With **<F1>** the cross section of the flow channel can be entered (needed for calculation of the flow rate). After the pitot tube is positioned in the flow channel, the display shows the speed (m/s) and the flow rate (Nm³/h). If the value indicated is stable, press **<Record>** to store the value in the intermediate memory. If a printout of the values should occur simultaneously to the recording in the intermediate memory, press **<F2>** (the complete content of the intermediate memory will be printed out).

Connections for pitot tube

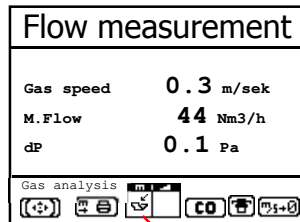

Measurement stored in intermediate memory

7.6. Biogas measurement (option)

	<p>For safety reasons only a short measurement (max. 5 minutes) of the fuel can be carried out. Longer measurements or continuous measurements are not permitted!</p>
---	--

The measurement of the fuel components can only be carried out with additional sensor equipment (CH₄- and H₂S sensor). For this purpose, the measuring hose of the instrument (connection sampled gas) must be connected to the gas supply of the motor at the measuring nipple (max. 100 hPa gas pressure). If the values indicated are stable, press **<Record>** to store the value in the intermediate memory. If a printout of the values should occur simultaneously to the recording in the intermediate memory, press **<F2>** (the complete content of the intermediate memory will be printed out).

In addition to the determination of the gas components, a pressure measurement (max. 100 hPa gas pressure) can be carried out. For this purpose the measuring hose of the instrument (connection draught) must be connected to the measuring nipple at the gas supply of the motor. The display shows the measurement value which can be stored while pressing **<Record>** and added to those results previous stored in the intermediate memory. The recorded value is shown on the display.

Analysis Biogas	
O ₂	0.3 %
CH ₄	44.25 %
H ₂ S	11 ppm
Analysis Biogas	
	

Measurement stored in intermediate memory

Pressure Biogas	
50.12 hPa	
Recorded value:	
50.12 hPa	
	

Measurement stored in intermediate memory

7.7. Soot...Oil trace

The sub-menu "**Soot...Oil trace**" enables the input of measured results for boiler temperature, soot dots and oil trace. Select the desired line on the display and activate the input with **<Enter>**. The input for boiler temperature and soot measurements 1-3 can be made one after the other with help of the instrument keyboard. Press **<Enter>** to store the value in the data record of the measurement.

Soot..Oil trace	
Boiler temp. :	66°C
1.Soot meas. :	-.-
2.Soot meas. :	-.-
3.Soot meas. :	-.-
Oil trace :	----
Select:	<input type="checkbox"/> <input checked="" type="checkbox"/>

The result of the oil trace check will be documented as follows:

- Place cursor on line "**Oil trace**"
- Consign the result with **<Enter>** ("**No**", "**Yes**" or "- - -")

Soot..Oil trace	
Boiler temp. :	66°C
1.Soot meas. :	1.0
2.Soot meas. :	0.5
3.Soot meas. :	1.5
Oil trace :	NO
Select:	<input type="checkbox"/> <input checked="" type="checkbox"/>

Once all inputs have been entered, press **<ESC>** to exit the menu. The measurement is now complete.

7.8. Measurement record and printout

Important: Once the gas analysis is completed, transfer the values recorded in the intermediate memory on the MM card, otherwise they would get lost by switch-off of the instrument!

Press **<Print>** (printer symbol) to enter the printing menu. The sampled data can be checked one more time („**View memory**“, **<Enter>** and scroll with the cursor keys).



The software keyboard enables the input or correction of the 6 lines text of the plant identification. („**Input text**“, **<Enter>**, to write text, see chapter 6).



All data correct? Then press „**Memory -> M**“ and **<Enter>** to transfer them in the internal memory or on the MM card ("Disk symbol" is shown in black in the measurement mode). The inputted text is taken over into the data record only by transfer on MM card.



Select („**Start printout**“ and **<Enter>**) to print out the data (only instruments with printer).



Press **<ESC>** to turn back to the gas analysis mode.

The functions „**View memory**“, „**Memory -> M**“ and „**Input text**“ can also be selected out of the measurement mode with **<Enter>**.

--ECOM-D--
Start printout
View memory
Memory -> M
Input text
Select:  

--ECOM-D--
Start printout
View memory
Memory -> M
Input text
Select:  

--ECOM-D--
Start printout
View memory
Memory -> M
Input text 
Select:  

--ECOM-D--
Start printout
View memory
Memory -> M
Input text
Select:  

Please care for a frictionless (direct sight) connection between the sending diode and the receiving diode on the printer. The maximal distance between both units should not exceed ca. 40 cm otherwise a trouble free transfer is no more ascertained in any case.



7.9. After Measurement



Let the probe cool down before stowing them!



Check the particle filter or condensate pad! It should be replaced when the contamination of the filter is equivalent to a soot number of approx. 2 - 3.



Empty the water trap or check condensate pad before transport of the instrument!

Emptying the water trap:

1. Pull the drain hose
2. Drain the condensate
3. Attach the drain hose again



8. Mean Value Measurement

By mean value measurement function, measurements can be sampled within an adjustable time frame and mean values can be calculated. Should the several measurement values or the mean value result be stored a storage place has to be selected as described in chapter 6. If the function “**Store**” is activated, based on this storage place all measurements will be written consecutively on the next storage places. If the function “**Store**” is not activated, the mean value result can be stored on MMC with **<Print>** / „**Memory** -> **M**”.

Once the fresh air calibration is completed, select the menu point „**Mean values**“. Before starting, the parameters „**Measurement time**“, „**Scanning**“, „**Printer**“ and „**Record**“ should be checked or modified if need be. The meaning is respectively:

- **Measurement time** = Time frame during which the mean values will be sampled
- **Scanning** = Time interval between the measurements considered for mean value calculation
- **Printer** = Documentation of measurements serving to the mean value calculation
- **Store** = All measurements for mean value calculation will be stored

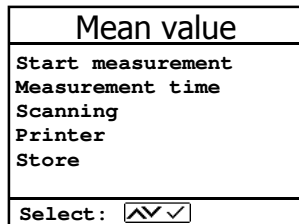
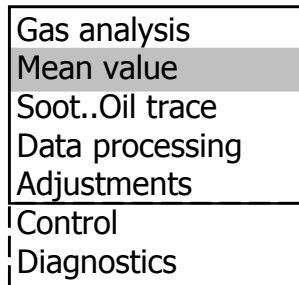

„**Measurement time**“ and „**Scanning**“ can be adjusted as follows:

- select menu point and confirm with **<Enter>**
- set the desired time using the numerical keys:
 - 0.01 = 1 sec = minimal value
 - 59.59 = 59 min : 59 sec = maximal value
- confirm with **<Enter>**

The settings for „**Printer**“ can be changed as follows:

- select menu point and confirm with **<Enter>**
- select desired adjustment with cursor keys
- confirm with **<Enter>**

The setting for „**Store**“ can be changed as follows:

- select menu point and confirm with **<Enter>**
- activate memory function with **<F1>** or
- deactivate it with **<F4>**

By ‘**Start measurement**’ / **<Enter>** the evaluation of the measurement values will be started. On the display the actual mean values will be shown (will be updated with new measurement values / switch to the actual values with cursor keys **<up/down>**). It is possible to scroll through the values with the cursor keys **<right/left>**. With **<F2>** you can interrupt and with **<F4>** stop the measurement.

O2	3.2 %
CO2	13.1 %
CO	0 ppm
Eff.	92.5 %
Losses	7.5 %
Exc. air	1.18
T. Gas	184 °C
T. Air	20 °C
Mean value	
15:35min	

After finishing the measurement time a protocol of the results with all mean values can be printed (only instruments with printer - key **<Print>**).

9. Adjustments

Additionally to those ecom-D functions described previously, various adjustments can be made in the instrument.

From the main menu, select the sub-menu "**Adjustments**" and confirm with **<Enter>**.

A selection of modifiable parameters, adjustable according to the application, is displayed.

Place the cursor on the desired line and press **<Enter>** to call up or modify the adjustment. The modifiable parameters are:

Adjustments	
Einheit	
Ref. O2	
Fuel type	
Air pressu	
Select:	<input checked="" type="checkbox"/> <input type="checkbox"/>
Set clock	
Paper feed	
Internal	

Unit (adjustment with **cursor keys**):

- Calculation of gas concentrations in:

- ppm = volume concentration (parts per million)
- mg/m³ = mass concentration per volume unit
- mg/kWh (undiluted) = mass concentration per power unit
- mg/MJ (undiluted) = mass concentration per power unit
- ppm (undiluted) = volume concentration (parts per million)
- mg/m³ (undiluted) = mass concentration per volume unit

Undiluted:

Conversion of the gas concentration on selected reference oxygen:

- mg/kWh and mg/MJ are always calculated on 0% O₂ basis

- Conversion formula

$$E_{\text{ref}} = E_{\text{meas}} * \frac{21 - O_{2\text{ref}}}{21 - O_{2\text{meas}}}$$

Second unit (adjustment with **cursor keys**):

-two different unit for one gas concentration possible

O₂ reference

(for ppm und mg/m³ - Input after pressing **<Enter>**):

- Input of O₂ reference value O_{2ref}

Fuel type (press <Enter> to access selection list):

- Modification of adjusted fuel type
(e.g. by measurements at combination-plants)

Air pressure (press <Enter> to access menu):

- Input of barometric air pressure for dew point calculation

Clock set (press <Enter> to access setting menu):

- Correction of internal clock with cursor keys

Paper feed (only instruments with printer)

(press <Enter> to activate paper feeding):

- Paper feed line by line

Internal (press <Enter> to open menu):

- Further instrument settings:

Print contrast

(only instruments with printer)

(press <Enter> to access setting menu):

- Print contrast adjustment with cursor keys

Display contrast

(press <Enter> to access setting menu):

- Display contrast adjustment with cursor keys

Key beep

(<F1> for YES / <F4> for NO):

- Acoustical signal by key pressing

Internal
Print contrast
Displ. contrast
Key beep
Language: English
Select: <input type="checkbox"/> <input checked="" type="checkbox"/> <input type="checkbox"/>
F1 Hotkey
F4 Hotkey
Eff. (C)
CO-Automatic
USB
Bluetooth
WLAN
Pitot-factor
Printout

Language: English (change with <Enter>):

- Info about selected language (3 languages selectable)

F1 Hotkey (selection after pressing <Enter>):

- Modification of adjusted menu the programme will open after pressing <F1>

F4 Hotkey (selection after pressing **<Enter>**):

- Modification of adjusted menu the programme will open after pressing **<F4>**

Efficiency (C) (**<F1>** for YES / **<F4>** for NO):

- Efficiency calculation with or without condensation gain

CO-Automatic (**<F1>** for YES / **<F4>** for NO):

- Adjustment for CO purging
 - YES = CO sensor switches on after purging automatically
 - NO (default) = CO sensor has to be switched on with **<F3>** after purging

USB (selection after pressing **<Enter>**):

- Adjustment of transfer speed (Cursor keys **<Up/Down>**) and protocol (Cursor keys **<Right/Left>**) for the USB interface (connection USB):
 - Protocol DAS = Protocol for the program DASNT
 - Protocol Enhanced = Protocol for the program DAS5

Bluetooth (option)

- (**<BLE>** no adjustment needed):
- Online data = Remote

WLAN (option)

- (selection after pressing **<Enter>**)
- Instrument as Access Point (for connection with mobile terminals):
- **(Start/Stop WLAN:** manual switching of WLAN connection
 - available only with deactivated Auto Connect)
 - **Access Point:** (**<F1>** for YES / **<F4>** for NO)
 - **(W.O.) Auto Connect:** Automatic connection (**<F1>** for YES / **<F4>** for NO)
 - **Security:** use password for connection (**<F1>** for YES / **<F4>** for NO)
the password is „**1234567890**“
 - **Channel:** Input channel (1 – 13)
(selection after pressing **<Enter>**)

Connection with existing network:

- (Start/Stop WLAN:** manual switching of WLAN connection
 - available only with deactivated Auto Connect)
- Existing Network:** available only with deactivated Access Point
- (W.O.) Auto Connect:** Automatic connection
(**<F1>** for YES / **<F4>** for NO)
- Network scan:** Search for available networks
(selection with **<Enter>**)
- WPA password:** Input of password for selected network

Pitot factor (selection after pressing **<Enter>**):

- Input of Pitot factor for flow rate calculation (standard = 0.93)

Printout (selection after pressing **<Enter>**):

- Text input for printout on measurement protocol (8 x 24 characters)
- Input the text of line 1 as follows:
 1. Activate character selection list with **<F4>**.
 2. Select keyboard type with **<F3>** (4 different keyboards available).
 3. Use the cursor keys to select the desired character
(selected character is outlined by black background).
 4. Confirm selection while pressing **<Enter>**.
 5. Repeat procedure until desired text is complete.
 6. Once input for line 1 is completed, deactivate the characters selection mode with **<F4>** and move to the second line with the cursor key **<Down>**.
 7. Once all lines have been processed as desired, exit the menu with **<ESC>**.

10. Control

The electrochemical sensors for gas analysis are submitted to a wearing process and do age. They alter their output values along the time depending on the gas concentration, the exposure time and the soiling grade of the sampled gas. The program monitors the sensors and corrects drifts.

But if the drifts and the correlated measurement errors increase, an error message is displayed. In this case the corresponding sensor must be changed by an authorized service center. The control menu informs about the current status values for the sensors.

Further information is also consigned on 3 display pages (use cursor keys to scroll):

- battery voltage (charging status);
is displayed as a symbol in all menus:

Full charge Half charge Empty



- operation hours since last service
- total operation hours
- date of the next recommended service
- phone number of the next service center
- software version
- serial number
- amount of CO switch-offs
- error amount

- Collection of the last maintenance

O2	19744 mV
CO	7 mV
Accu	6.09 V
Operation hours	: 8.45 hrs
Total	: 18.75 hrs
Next unit check	: 01.07.10
Service tel.	:02371-945-303
Further pages:	

Program version	:V1.2 19.11.09
Serial no.	:EN2-0001
CO purges	: 15
Error counter	: 21
Operation hours	: 8.45 hrs
Total	: 18.75 hrs
Next unit check	: 01.07.10
Service tel.	:02371-945-303
Further pages:	

Last service (history)	
25.08.09	88 hrs
14.08.10	145 hrs
23.08.11	205 hrs
19.08.12	322 hrs
--.--.--	
--.--.--	
Further pages:	

11. Data Processing

11.1. Communication

If a MM card is inserted in the slot, so it will be used as record medium. The menu „**Data processing**“ offers the following functions:

Data processing	
Select	
View	
Memory (M)	
Format	
Quit with:	
DRT <-> PC !	
Datalogger	

Select:

For search or creation of plant files in the scope of assigning measurement values (see chapter 6.).

View:

Recorded values of the selected plant can be viewed (see chapter 6.).

Memory (M):

Here all stored measurements (sorted by record number) can be viewed. Single measurement results can be called up as follows:

- Select desired record number with the cursor keys and confirm with **<Enter>**
- Scroll with the cursor keys
- Press **<ESC>** to exit

	Date		Fuel type
1	01.09.09	11:01	Fuel oil
2	01.09.09	11:02	Fuel oil
3	01.09.09	11:04	Fuel oil
4	01.09.09	11:07	Fuel oil
5	01.09.09	11:11	Fuel oil
6	01.09.09	11:23	Fuel oil
7	01.09.09	11:44	Fuel oil
8	01.09.09	11:53	Fuel oil
Select:			

Format:

This function is usually needed by initial adjustment of the instrument at our factory (preparation of MM card for data recording).

Caution: All stored values will be cancelled!

DRT <-> PC!:**Load data:**

Enables the data import from e.g. ecom software (available on our website „www.ecom.de“). See chapter „Technical Data“ for data format information (please observe the transfer options of your software!).

Proceed as follows:

- Connect ecom-D and PC via USB cable.
- Select “**Load data**“ and confirm with **<Enter>**.
- Answer the displayed question with **YES (<F1>)**.
- Decide if the data recorded can be cancelled (**<F1>** for **YES** / **<F4>** for **NO**).
- Start the data transfer on your PC.

Send data:

With this function the data records completed with measurement values can be transferred to the PC program (procedure similar to chapter „**Load data**“).

11.2. Data logger

Here a Data logger record (“**Data logger**“ and key **<OK>** / on top right on the display appears the disk symbol) can be started or finished (just available when using the multi-media-card). With **<Record>** you can interrupt and continue the record (only in gas analysis). For each recording one file will be written on the card. The files will be numbered consecutively (J2KDL-00.csv, J2KDL-01.csv and so on) and can be transferred to PC with a card reader. The length of a dataset is 500 byte which means that on a 32 MB card 64000 measurements could be recorded.

Save to MMC (min. 1 second / max. 999 seconds):

Adjustment of the interval time for data logger recordings.

CSV+Header (<F1> for YES / <F4> for NO):

Adjustment of data logging with or without column headings.

11.3. Data logging with DASNT2

In addition to data logger recordings the data could also be transferred online via USB, Bluetooth (option) or via data interface to the software "**DASNT2**". For the USB connection, a driver is required. Software and USB driver are available free of charge from the ecom website. The following transfer parameters must be set at **ecom-D** ("**Adjustments**" / "**Internal**" / "**USB** "):

- **1200 Baud**
- **Protocol DAS**

Please note the hints in the software manual.

11.4. Data processing with DAS5

To display and storage of measured values and measured value gradients the software "**DAS5**" is available. With the help of a multi-media card customer and measurement data can be exchanged between software and instrument. An online connection to store measured values and measured value gradients is possible with USB or WLAN. For the USB connection, a driver is required. Software and USB driver are available free of charge from the ecom website. The following transfer parameters must be set at **ecom-D** ("**Adjustments**" / "**Internal**" / "**WLAN** "):

- **1200-38400 Baud** (setting as in the software "**DAS5**")
- **Protocol Enhanced**

For the wireless connection (WLAN), the following transfer parameters have to be set at **ecom-D** ("**Adjustments**" / "**Internal**" / "**WLAN** "):

- **Access Point = YES**
- **Auto Connect = YES**

Please note the hints in the software manual.

11.5. Data processing with App

To display and storage of measured values, the Apps “**ecom connect WiFi**” or „**ecom connect BLE**“ for smartphones (iOS or Android) are available. Test results are stored along with customer information in a pdf-file and can be sent f.e. as email attachment. Links to free download of the Apps can be found on the ecom website. For the wireless connection (WLAN), the following transfer parameters must be set at **ecom-D**

(**"Adjustments" / "Internal" / "WLAN"**):

- **Access Point = YES**
- **Auto Connect = YES**

12. Diagnostics

12.1. Fault diagnostic

The ecom-D is able to receive and to process information provided via cable transfer by the ecom-AK (read-out head for digital firing automates).

Out of the main menu, select the sub-menu **"Fault diagnostic"** and confirm with **<Enter>**. The ecom-D tries to establish a connection with the ecom-AK (display message: „Search in process“). By successful attempt, the current burner operation stand is displayed as a graphic on the display. The operation stand can be recorded (max. 120 sec). Press **<Enter>** to initiate a new recording (reset).

ecom-AK



Cable connection to AUX connector

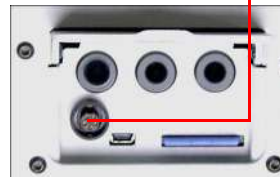

ecom-D

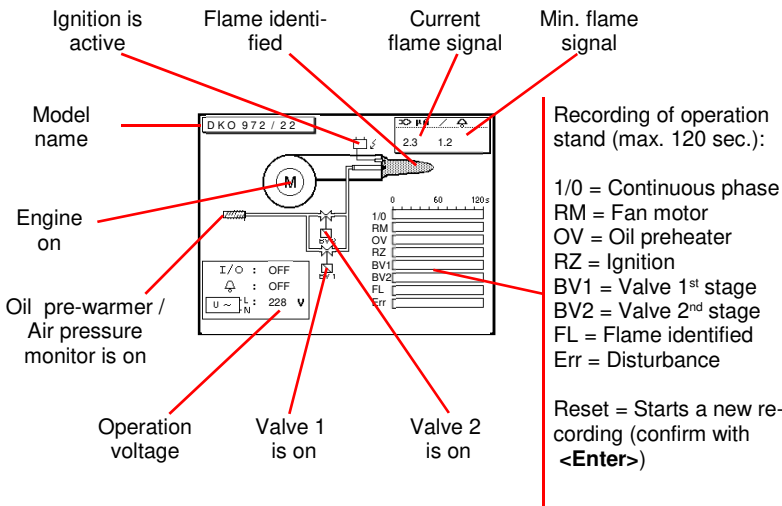

Use the cursor keys (Up/Down) to call up further data of the firing automate. On the 2nd display page the current error and the number of burner starts are displayed.

Number of burner starts at a total resp. since reset of firing automate

Current error	
No error !	
Number of startups total	677
Service counter actual	142
Further pages:	

Current error

The 3rd display lists information about error history (type and volume of information depending on firing automate).

Last 2 errors (Satronic)
Last 5 errors (Siemens)
(Scroll errors using
<Right/Left>)

Error history	
Flame signal during straylight check	
After:	001 12 sec
Stat :	2.2 µA 225 V
Total :	46
Straylight :	22
Safety time :	9
Loss of flame :	17
FT/LW :	0
Select:	

Error statistics
(number of errors)

The 4th display page lists information about the monitoring times (type and volume of information depending on firing automate).

Monitoring times of firing automate

Timing values	
Safety time (ISA)	4.9 sec
Delay time valve 2	40.0 sec
Pre-ignition time	17.0 sec
Post-ignition time	20.0 sec
Delay straylight sup.	11.5 sec
Straylight supervision	5.0 sec
Rest time TSA (actual)	4.1 sec
Select:	

12.2. delta-T Measurement

With the ecom-D a difference temperature measurement is possible. For measurements at piping (e.g. water-in and water-out of heating systems), special temperature sensors are needed, available from your authorized ecom agency. Out of the main menu point "**Diagnos-tics**" select the sub-menu "**dT measurement**" and confirm with **<Enter>**.

The instrument indicates the temperature T1 (sensor at connection „Gas temperature“), the temperature T2 (sen-sor at connection „Air temperature“) and the difference between both tempera-tures (T1 - T2). Press **<Memory>** to store the result in the intermediate memory. A printout can be started with **<Print>**.

dT measurement	
T1	70.4 °C
T2	56.3 °C
dT	14.1 °C

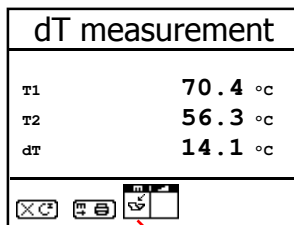

Measurement stored in intermediate memory

12.3. Heating Check (Option)

The heating check is a simple, expressive process to evaluate a complete heating plant (heat production, distribution and transfer) from the energetic point of view.

Hereby the single plant components get inspected by the heating engineer in a combination of measurements and visual assessment and valued in regards of their energetic quality acc. to a negative point system of maximum 100 points.

The higher the score, the farer the current plant is away from the desirable energetic stand and the higher the energy saving potential would be if modernization measures are conducted.

In combination with the special probes required hereto, the ecom-D is able to perform the measurement of the heating check parameters: gas losses, ventila-tion losses and surface losses.

Out of the main menu point "**Diagnos-tics**", select the sub-menu "**Heating Check**" and confirm with **<Enter>**.

Heating Check	
Gas losses	
Surface losses	
Ventilation losses	
Results	
Cancel	
Select :	<input checked="" type="checkbox"/> <input checked="" type="checkbox"/>

The **gas losses measurement** is to be performed with the instrument's sampling probe in the gas core stream after menu call up (see chapter 7.1.). Once the measurement is recorded with **<Memory>** (disk symbol) the conversion of the measurement results in negative points is available under the menu point „**Results**“.

O2	3.2 %
CO2	13.1 %
CO	0 ppm
Eff.	92.5 %
Losses	7.5 %
Exc. air	1.18
T.Gas	184 °C
T.Air	20 °C

Gas analysis m

Measurement stored in intermediate memory

The **surface losses measurement** is performed by a temperature sensor specific for surfaces. The temperature difference between boiler surface and room temperature (air temperature sensor) is determined and the percentage loss is calculated. Once the menu point is called up, the boiler performance must be entered. To easy the measurement width, depth and height of the boiler can also be entered (dimensions will be memorized for surface calculation). Please proceed as follows:



Temperature sensor for surfaces



- activate respective input window with **<Enter>**
- inputs values using the keys numerical function
- confirm input with **<Enter>** or:
- adjust values using the cursor keys **<Right/Left>**

Surface loss	
	P.Boiler 24,5 kW
	Width 1,20 m
	Depth 1,20 m
	Hight 1,20 m
Modify: <input type="button" value="A"/> <input type="button" value="D"/> <input type="button" value="C"/> <input type="button" value="V"/>	
<input type="button" value="Start"/>	<input type="button" value="Start"/> +

If no boiler dimensions are entered, press **<F1>** (Start) to activate the measurement recording. Here the dimensions for all surfaces must be entered.

Press **<F3>** (Start + ->) to start the real measurement. Proceed as follows:

- select surface (boiler side) to be measured with **<F1>** or **<F2>**
- position surface sensor
- record temperature difference with **<Memory>** - up to 10 values can be recorded per surface out of which a mean value will be calculated automatically
- if need be, cancel measurements with **<F4>**
- repeat this procedure for each surface

Surface losses																						
-0-	<table border="0"> <tr><td>Wid.</td><td>---</td><td>m</td></tr> <tr><td>Hei.</td><td>---</td><td>m</td></tr> <tr><td>Surf</td><td>---</td><td>m²</td></tr> <tr><td>T.S.</td><td>---</td><td>°C</td></tr> <tr><td>T.A.</td><td>---</td><td>°C</td></tr> <tr><td>T.S.</td><td>21.5</td><td>°C</td></tr> <tr><td>T.A.</td><td>21.5</td><td>°C</td></tr> </table>	Wid.	---	m	Hei.	---	m	Surf	---	m ²	T.S.	---	°C	T.A.	---	°C	T.S.	21.5	°C	T.A.	21.5	°C
Wid.	---	m																				
Hei.	---	m																				
Surf	---	m ²																				
T.S.	---	°C																				
T.A.	---	°C																				
T.S.	21.5	°C																				
T.A.	21.5	°C																				
	<div style="display: flex; justify-content: space-between; align-items: center;"> Surfa. ↓ Store → 🗑️ </div>																					
Surface losses																						
-1-	<table border="0"> <tr><td>Wid.</td><td>1.20</td><td>m</td></tr> <tr><td>Hei.</td><td>1.20</td><td>m</td></tr> <tr><td>Surf</td><td>1.44</td><td>m²</td></tr> <tr><td>T.S.</td><td>40.5</td><td>°C</td></tr> <tr><td>T.A.</td><td>21.5</td><td>°C</td></tr> <tr><td>T.S.</td><td>42.5</td><td>°C</td></tr> <tr><td>T.A.</td><td>21.5</td><td>°C</td></tr> </table>	Wid.	1.20	m	Hei.	1.20	m	Surf	1.44	m ²	T.S.	40.5	°C	T.A.	21.5	°C	T.S.	42.5	°C	T.A.	21.5	°C
Wid.	1.20	m																				
Hei.	1.20	m																				
Surf	1.44	m ²																				
T.S.	40.5	°C																				
T.A.	21.5	°C																				
T.S.	42.5	°C																				
T.A.	21.5	°C																				
	<div style="display: flex; justify-content: space-between; align-items: center;"> Surfa. ↓ Store → 🗑️ </div>																					

Once all surface temperatures have been determined, quit the menu with **<ESC>**. The surface losses get automatically calculated. The value conversion in negative points is available in the menu point „**Results**“.

The **ventilation loss** measurement is performed by a flow probe 30 sec. after burner switch-off. This measurement can be performed at the earliest 5 min. after instrument's switch-on as the pressure sensor requires this period of time for stabilization. Once the menu is called up, the values for air pressure, external temperature, boiler performance and exhaust gas pipe diameter must be entered. Hereto proceed as follows:

- open respective window with **<Enter>**
- input figures using numerical function of keys
- confirm input with **<Enter>**
- or:
- adjust values using the cursor keys **<Right/Left>**



Flow probe

Press **<F1>** (Start) prior to going thru the following steps to start the measurement:

- release tubing of the flow probe
- wait for zeroing of pressure sensor
- re-connect tubing of the flow probe
- position flow probe into exhaust gas pipe (observe mark for flow direction)
- switch off burner and simultaneously press **<F1>**
- or:
- press **<F2>** to activate timer (5 sec.) and switch off burner by beep
- after approx. 30 sec. the measurement value converted in negative points is available

An overview of the measurements is available under „**Results**“. Press **<Print>** to print them out.

Heating Check	
Gas losses	√
Surface losses	√
Ventilation losses	√
Results	
Cancel	
Select:	<input type="checkbox"/> <input checked="" type="checkbox"/> <input checked="" type="checkbox"/>

Heating Check	
Gas loss	2.9 %
Points	2.6
Surf. Lo.	2.29 %
Points	3.4
Vent. lo.	3.11 %
Points	3.0
Quit with:	<input type="checkbox"/> <input checked="" type="checkbox"/>

12.4. 4 Pa Measurement (option)

The simultaneous operation of room-dependent firing place and air evacuation system can lead to dangerous low pressure conditions. With the ecom-D it is possible to check the low pressure limit value of 4 Pa and to document in a diagram the time course of the low pressure value. Once the menu point is called up, the measurement is to be performed as follows:

- connect capillary hose for room where burner is installed to „-“
- connect capillary hose for reference place (staircase or outside air to „+“
- operate firing and evacuation systems with maximal performance
- open window resp. connection door to burner room and check the correct evacuation of the exhaust gases
- zero pressure sensor with **<F4>**
- position capillary hose for reference location
- start record pressure value course with **<F1>** (Start)
(an acoustical signal is issued every 30 sec. which can be deactivated / re-activated by pressing **<F2>**)
- record pressure by opened window resp. connection door
- close window resp. connection door after approx. 30 sec. and check low pressure
- after approx. 30 sec. open window resp. connection door and check zero point
- close window resp. connection door after approx. 30 sec. and check low pressure
- after approx. 30 sec. re-open window or connection door and check zero point
- after approx. 30 sec. close window resp. connection door and check low pressure

Once the measurement time is completed, the diagram can be viewed on the display (use **<F3>** to emphasize illustration 1x, 2x, 4x, 8x times or A for automatic). Start a printout if needed with **<Print>**.

12.5. Pressure Tests (option)



1. Use only air or inert gas for check !
2. Respect the „Technical Rules for Gas installations“!

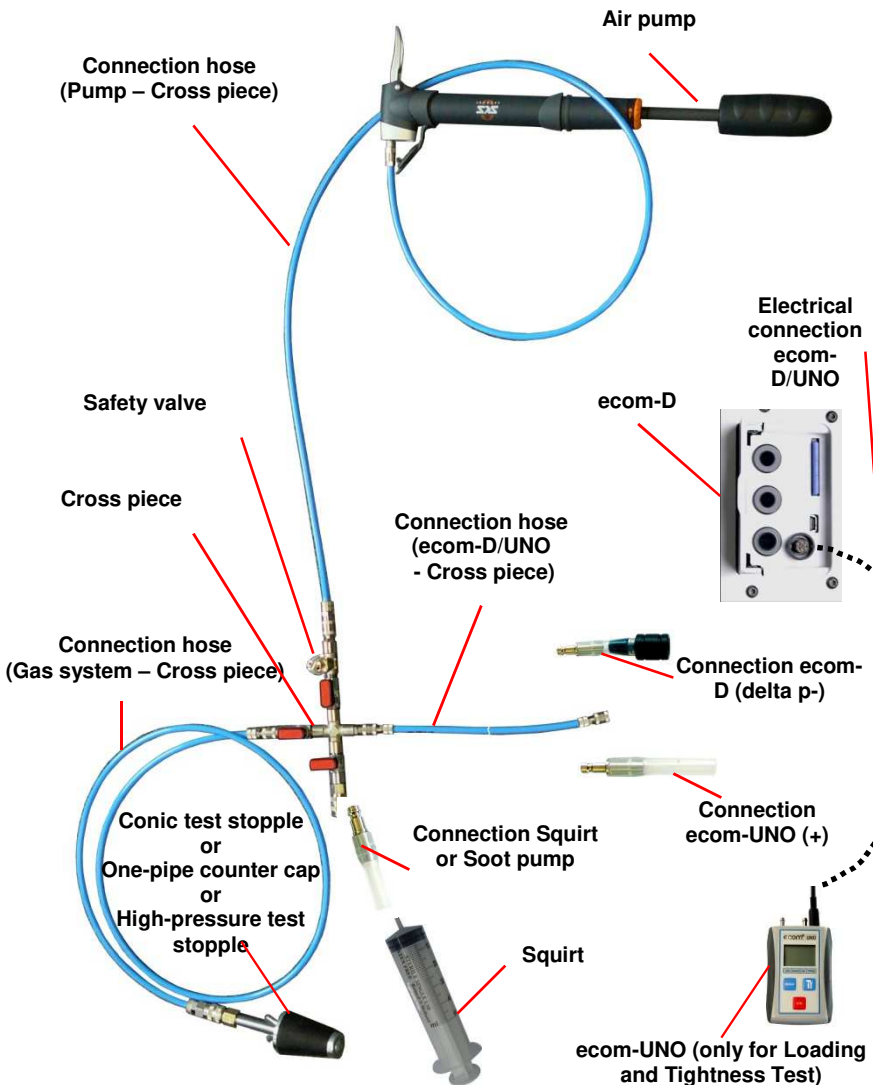

Call up the menu „**Pressure Tests**“ with the pre-programmed measurement routines „**Pressure Test**“, „**Loading Test**“, „**Tightness Test**“ and „**Usage property**“. Parameters to each measurement routine can be adjusted in the menu „**Setup**“.

Setup

Scroll with cursor keys <Up/Down> until the menu “**Setup**”. Press <Enter> to activate the menu. The following parameters can be adjusted for the corresponding measurement routine:

Pressure Test

- Stabilization time (1 - 10 min, default: 1 min)
- Measurement time (10 - 120 min, default: 5 min)

Loading Test

- Stabilization time (1 - 10 min, default: 1 min)
- Measurement time (10 - 120 min, default: 10 min)
- Test pressure (900 - 1200 hPa, default: 1000 hPa)

Tightness Test

- Stabilization time (1 - 10 min, default: 1 min)
- Measurement time (10 - 120 min, default: 10 min)
- Test pressure (90 - 160 hPa, default: 150 hPa)

Usage property

- Stabilization time (1 - 270 min, default: 1 min)
- Measurement time (10 - 240 min, default: 10 min)
- Test pressure (20 - 160 hPa, default: 50 hPa)
- Max. operation pressure (10 - 100 hPa, default: 23 hPa)
- Air pressure (800 - 1200 hPa, default: 1013 hPa)

Each parameter can be adjusted the same way:

1. Select the parameter with cursor keys <Up/Down>.
2. Press <Enter> to activate.
3. Type in the value with the instrument keyboard.
4. Confirm with <Enter>.

Pressure Test

The “**Pressure Test**” up to 100 hPa is deposited as a measurement routine in the ecom-D. Proceed as follows:

1. Close the conduit with a suitable adapter (test stopple, high-pressure stopple or one-pipe counter cap).
2. Connect the components as described before.
3. Scroll with cursor keys <Up/Down> to the menu “**Pressure Test**”. Activate with <Enter>.
4. Create the pre-adjusted test pressure (max. 100 hPa) with the air pump.
5. Interrupt the connection to the air pump (switch-off the ball valve) and start “**Pressure Test**” with <Enter>.
6. Wait for stabilization time (the measurement will start automatically).
7. Once the measurement time is over, the result is displayed and can be printed by pressing <Print>.
8. If the menu “**Pressure Test**” is selected again, so the result can be called up with <F4> (as long as the ecom-D is on) or a new measurement can be started with <F1>.

Loading Test

The „**Loading Test**“ acc. to DVGW – TRGI Process Instructions G 600 by pipes (operation pressure up to 100 hPa) is deposited as a measurement routine in the ecom-D. Proceed as follows:

1. Connect the ecom-UNO to the connection AUX of the ecom-D.
2. Close the conduit with a suitable adapter (test stopple, high-pressure stopple or one-pipe counter cap).
3. Connect the components as described before.
4. Scroll with cursor keys <Up/Down> to the menu „**Loading Test**“. Activate with <Enter>.
5. Create the pre-adjusted test pressure with the air pump (the unit beeps as soon as the pressure level is achieved).
6. Interrupt the connection to the air pump (switch-off the ball valve).
7. Wait for stabilization time (if the pressure remains in the range „test pressure +/- 10% during stabilization time, so the measurement will start).
8. Once the measurement time is over, the result is displayed and can be printed by pressing <Print>.
9. If the menu „**Loading Test**“ is selected again, so the result can be called up with <F4> (as long as the ecom-D is on) or a new measurement can be started with <F1>.

Tightness Test

The „**Tightness Test**“ acc. to DVGW – TRGI Process Instructions G 600 by pipes (operation pressure up to 100 hPa) is deposited as a measurement routine in the ecom-D. Proceed as follows:

1. Connect the ecom-UNO to the connection AUX of the ecom-D.
2. Close the conduit with a suitable adapter (test stopple, high-pressure stopple or one-pipe counter cap).
3. Connect the components as described before.
4. Scroll with cursor keys <Up/Down> to the menu „**Tightness Test**“. Activate with <Enter>.
5. Create the pre-adjusted test pressure with the air pump (the unit beeps as soon as the pressure level is achieved).
6. Interrupt the connection to the air pump (switch-off the ball valve).
7. Wait for stabilization time (if the pressure remains in the range „test pressure +/- 10% during stabilization time, so the measurement will start).
8. Once the measurement time is over, the result is displayed and can be printed by pressing <Print>.
9. If the menu „**Tightness Test**“ is selected again, so the result can be called up with <F4> (as long as the ecom-D is on) or a new measurement can be started with <F1>.

Usage property

The „Usage property“ acc. to DVGW – TRGI Process form G 624 by conduits is deposited as a measurement routine by the ecom-D. The calculation of the leak rate happens automatically according to the following equation and corresponds herewith to the procedure of the DVGW-TRGI Process Form G 624:

$$VB = V/TM * ((PA + P1)/(PA + P2)-1) * PB/P1 * f$$

with: **VB** = Gas leak volume in operation state (l/h)

V = Pipe content in litres

TM = Measurement duration in hours

PA = Barometer stand in hPa

P1 = Test pressure at meas. beginning in hPa

P2 = Test pressure at measurement end in hPa

PB = Maximal gas operation pressure in hPa

f = Factor for consideration of gas type

Proceed as follows:

1. Close the conduit with a suitable adapter (test stopple, high-pressure stopple or one-pipe counter cap).
2. Connect the components as described before.
3. Scroll with cursor keys <Up/Down> to the menu „Usage property“. Activate with <Enter>.
4. Type in the air pressure (**PA**) with the instrument keyboard and confirm with <Enter>.
5. Choose the gas type (**f**) with cursor keys <Up/Down> and confirm with <Enter>. The following gas types are recorded with their respective factors:

Natural Gas, Air, Town Gas, Propane, Butane, Hydrogen

6. Type in the maximal operation pressure (**PB**) with the instrument keyboard and confirm with <Enter>.

7. The pipe volume (**V**) is needed for the calculation of the leak rate. The ecom-D offers two possibilities:

a. Type in pipe volume (**V**):

- Choose **NO** at the inquiry „Calculate Volume automatically?“.
- Type in pipe volume (**V**) with the instrument keyboard and confirm with **<Enter>**.

b. Calculate pipe volume automatically (**V**):

- Choose **YES** at the inquiry „Calculate Volume automatically?“
- Connect the squirt or soot pump as described before.
- Open ball valve and wait until the pressure is stabilized.
- Choose squirt or soot pump with the cursor keys **<right/left>**.
- Start volume calculation with **<Enter>**.
- Infer the test volume with squirt or soot pump. The decrease of pressure must be min. 2 hPa (otherwise operate squirt or soot pump several times).
- Close ball valve and confirm with **<Enter>**.
 - Choose number of strokes with the cursor keys **< right/left >** and confirm with **<Enter>**.

8. Create the pre-adjusted test pressure with the air pump (the unit beeps as soon as the pressure level is achieved).

9. Interrupt the connection to the air pump (switch-off the ball valve).

10. Wait for stabilization time (if the pressure remains in the range „test pressure +/- 10% during stabilization time, so the measurement will start).

11. Once the measurement time is over, the result is displayed and can be printed by pressing **<Print>**.

12. If the menu „**Usage property**“ is selected again, so the result can be called up with **<F4>** (as long as the ecom-D is on) or a new measurement can be started with **<F1>**.

13. Maintenance Tips



Do not use other sensors or feelers from other manufacturers otherwise the TÜV / DIN EN approval will not be valid anymore!

To secure the accuracy of your measuring instrument we recommend the annual check by an authorized ecom partner. In the case of strong demand (e.g. permanent several hours of measurement per day, rough conditions etc.) shorter intervals between checks should be selected - please contact your ecom partner. All ecom partners are listed under www.ecom.de.



Service made by service centers non-authorized by ecom GmbH will result in a complete and immediate loss of any warranty!

The following advices will be of help for the daily check and maintenance of single parts or assemblies:

Empty condensate trap (Instruments with gas cooler):

The condensate collects the humidity of the sampled gas. Check regularly how much liquid has been gathered. Empty the trap in time and avoid humidity to enter the instrument. Remove condensate hose from nipple and let the condensate out. **Note:** The condensate hose must be attached to the nipple during the measurement!



Change Fine dust filter (Instruments with gas cooler)

Screw off the cover of the condensate trap/gas cooler and check the state of the particle filter. Change it once the filter has a grey color (number 2 - 3 of the soot comparison scale).

Condensate pad (Instruments without gas cooler)

Regularly check the condition of the condensate pad. It should be changed:

- If it is soiled darker than no. 3 on the soot scale
- If its extension is on mark "MAX"

Replace the condensate pad as follows:

1. Remove hose from the cap and unscrew the cap
2. Unscrew the retaining bolt with spring
3. Replace old condensate pad against new
4. Screw on retain bolt with spring again
5. Screw on cap and replace the hose to the cap

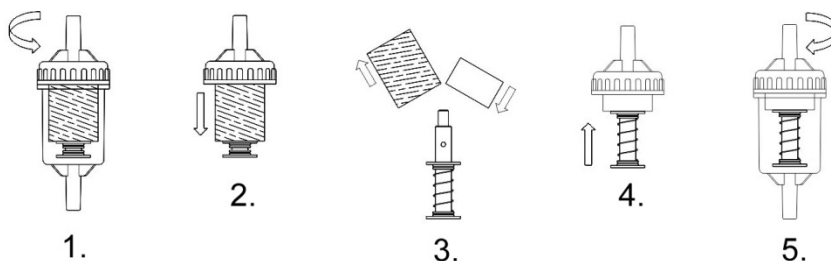

Sensors

The sensors get calibrated with the reference gas fresh air by each switch-on. Their state is permanently checked by the instrument. New sensors age along the operation time because of the wearing of the reagents (oxygen sensor) and due to soiling respectively exceeding concentrations beyond the nominal measurement range (toxic sensors). The output values of the sensors are (menu "**Control**"):

O ₂	approx. 12000 mV
Others	0 mV (+/- 150)

If an error message is displayed during calibration and cannot be eliminated despite several calibration phases, so the instrument must be checked by a qualified and authorized service center. The oxygen sensor must show a value of >7000 mV, otherwise it must be changed by an authorized service center.

The CO sensor is protected against overload by the internal program. If the limit value of 4000 ppm is exceeded, a second pump switches on and flows the sensor with fresh air.

After sufficient purging time (X behinds CO disappears) the sensor can be reintegrated into the measurement system with <F3> (if you choose „Yes“ at „Adjustments“ / „Internal“ / „CO-Automatic“ the CO sensor switches to measurement automatically). The sensor can also be manually be excluded from the measurement system with <F3>..

Probe and tubing

Depending on the frequency of use, probe and tubing should be regularly cleaned in order to release particle deposits and to prevent early wearing due to corrosion.

- Release the connections at the instrument and at the probe grip to free the tubing.
- Clean it (flow warm water in then dry respectively blow water drops out.
- Slightly grease the O-rings of the tubing connections from time to time with acid-free grease.

Change printer paper roll

- Release the printer cover (press lock downwards).
- If necessary, extract the paper rest out of the printer. Hereto select **"Adjustments"/"Paper feed"/<Enter>**.
- Remove the plastics tube of the previous roll.
- Insert the paper end in the slot under the transport roll (paper roll inner side facing you while inserting the paper).
- Convey approx. 3 cm paper thru the printer (**"Adjustments"/"Paper feed"/<Enter>**).
- Lay the paper roll in the corresponding hollow.
- Insert the paper thru the slot of the printer compartment cover and close the latest.

**Locking
printer cover**



14. Technical Data

Parameter	Range	Principle
O ₂	0 ... 21 vol. %	Electrochemistry
CO	0 ... 4000 ppm	Electrochemistry
NO (option)	0 ... 5000 ppm	Electrochemistry
NO ₂ (option)	0 ... 1000 ppm	Electrochemistry
SO ₂ (option)	0 ... 5000 ppm	Electrochemistry
H ₂ S (option)	0 ... 5000 ppm	Electrochemistry
CO% (option)	4000 ... 63000 ppm	Electrochemistry
CO ₂ (option)	0 ... 20 vol. %	Infrared
CH ₄ (option)	0 ... 100 vol. %	Infrared
CO ₂	0 ... CO _{2max}	Calculation
T-Gas	0 ... 500 °C	NiCr-Ni
T-Air	0 ... 99 °C	Semi-conductor
Differential pressure	0 ... +/- 100 hPa	DMS bridge
Efficiency	0 ... 120 %	Calculation
Losses	0 ... 99,9 %	Calculation
Excess air	1 ... ∞	Calculation
CO undiluted (adjustable ref. O ₂)		Calculated
Flue gas dew point		Calculated

Power supply	Charger 230 V / 50 Hz~; Battery 6 V / 3,3 Ah
Protocol printer	integral; 58 mm paper width (option)
Indication	graphic display; backlit
Dim. (W x H x D)	from approx. 200 mm x 130 mm x 80 mm (depending on selected features)
Weight	from approx. 2 kg (depending on selected features)
Application limits	+5 °C to +40 °C; max. 90 % RH, non-condensing

Subject to technical changes

V2.3 / 06.2018

ecom GmbH

Am Großen Teich 2

D-58640 Iserlohn

Phone: +49 (0) 2371 - 945-5

Fax: +49 (0) 2371 - 40305

Internet: <http://www.ecom.de>

eMail: info@ecom.de

15. FAQ

Where do I find important instrument information?	In the menu „Control“ all important instrument informations are shown (e.g. battery voltage, sensor values, unit number, next service date, operation hours etc.). With the arrow keys stands you can switch to the second page.
How long is the life span of the sensors?	The life span depends on the operating hours and the instrument equipment. The life span of the toxic sensors (CO, NO, SO ₂ , NO ₂) is affected by high gas concentrations and a not sufficient purging. The life span for these sensors amounts to on the average between 4 and 6 years. The life span of the O ₂ sensor is independent of the operating hours and amounts to approx. 2 years.
Which sensors can I exchange?	The following sensors are exchangeable: <ul style="list-style-type: none"> - O₂ sensor - CO sensor (precalibrated) - NO sensor (precalibrated) - SO₂ sensor (precalibrated / only together with CO sensor)
The instrument shows the error message „O ₂ sensor 0 mV“!	The sensor must be renewed.
The instrument shows the message „Check required“!	This message appears automatically every 12 months or after 250 operating hours. Note: This is a recommendation to let check the instrument. The instrument is however still ready for use.
The instrument shows the error message „T-Gas“ or „T-Air“!	Possible reasons could be: <ul style="list-style-type: none"> - Cable is broken (at the plug) - T-Air sensor is broken - Thermocouple is broken - Cable is defective Note: The error messages can be ignored at the D by pressing „Enter“. Calculations that depends on these temperatures are not implemented.
The instrument shows wrong or inaccurately CO ₂ values!	Possible reasons could be: <ul style="list-style-type: none"> - O₂ is defective (CO₂ values are calculated from the O₂ values) - Pump is not working correctly - Leakage in the gas way - condensate trap / gas cooler is clogged

My instrument cannot be switched on!

- Please check the mains cable
- Please check the fuse
- Please check mains connection (Plug socket switched on?)
- Please load the accumulator min. 8 hours (Accumulator could be over-discharged)

My instrument does not print!

Please check whether the printer paper is correctly inserted. The thermal printer writes only on the thermally sensitive side. Please use always the correct paper for the printer, you will prevent defects at the printer. Please make sure that the printer is clean (no chads in the drive).

Can I change the printout?

You can change the printout (Menu: Adjustments).

Hint: If you have several instruments of the same type, you can locate an error by exchanging the accessories (probe, hose, temperature sensor etc.).

If further questions or problems should arise, please contact the next authorised service centre.

Description of data record ecom-D with Multi Media Card

Format data logger records: J2KDL-xx.csv (separation mark between values = comma)

Format punctual measurements: J2KDV.txt (separation mark between values = comma)

Column	Description	Remark / Example
A	Date	DD.MM.YYYY (also US-Version)
B	Time	HH:MM:SS (also US-Version)
C	O ₂ in vol.%	0,0 - 21,0
D	CO in ppm	0 - 4000
E	NO in ppm	0 - 5000
F	NO ₂ in ppm	0 - 1000
G	SO ₂ in ppm	0 - 5000
H	CO converted*	
I	NO converted*	
J	NO ₂ converted*	
K	NO _x converted*	
L	SO ₂ converted*	
M	T. Gas in °C or °F	0 - 500 (US-Version with other range in °F)
N	T. Air in °C or °F	0 - 99 (US-Version with other range in °F)
O	Draught in hPa	0,00 - 20,00
P	CO ₂ in vol.%	0,0 - 25,0
Q	Efficiency in %	0,0 - 120,0
R	Losses in %	0,0 - 100,0
S	Excess air	> 1,00
T	Dew point in °C oder °F	0 - 500 (US-Version with other range in °F)
U	Poisoning index	> 0,0
V	O ₂ (gas channel check) in vol.%	0,0 - 21,0
W	CO (gas channel check) in ppm	Related to 0,0 vol.% O ₂
X	CO (gas channel check) in ppm	Measured value
Y	O ₂ (O ₂ check) in vol.%	0,0 - 21,0
Z	T. Boiler	0 - 999
AA	T. Sensor	0 - 99
AB	O ₂ reference	0,0 - 21,0
AC	Unit	0=ppm; 1=mg/m ³ ; 2=mg/kWh; 3=mg/MJ
AD	Norm	N = converted to O ₂ ref.
AE	Fuel type number	Index acc. to instrument table
AF	Fuel type text	Text acc. to instrument table
AG	Soot 1	0,0 - 9,9
AH	Soot 1	0,0 - 9,9
AI	Soot 1	0,0 - 9,9
AJ	Oil trace	0=no; 1=yes;
AK	20 characters text	
AL	20 characters text	
AM	16 characters text	
AN	Serial number	
AO	CO (O ₂ check) in ppm	
AP	Zug (O ₂ check) in hPa	
AQ	C,H,I	
AR	Number copy data	
AS	T1 (deltaT-measurement)	
AT	T2 (deltaT-measurement)	
AU	Velocity	m/s
AV	CO Environment	CH-version = Kind of control
AW	free	CH-version = Load range
AX	Comment text	
AY	Comment text	
AZ	Comment text	
BA	Comment text	
BB	H ₂ in ppm	CH version = Oil consumption
BC	H ₂ converted*	CH version = Thermal output
BD	Sensor 6 in ppm	CH version = Operation hours counter
BE	Sensor 6 converted *	CH version = Code

BF	dP (velocity) in Pa	0 – 1000,00
BG	Air pressure in hPa	300 – 1100
BH	Unit 2	0=ppm; 1=mg/m ³ ; 2=mg/kWh; 3=mg/MJ; 4=ppmN; 5=mg/m ³ ; 6=---
BI	CO (Unit 2)	
BJ	NO (Unit 2)	
BK	NO ₂ (Unit 2)	
BL	NO _x (Unit 2)	
BM	SO ₂ (Unit 2)	
BN	Analogue input 1	
BO	Analogue input 2	
BP	Sensor 7 in ppm	
BQ	Meas. gas volume in l/min	
BR	Free	
BS	O ₂ Biogas	
BT	CH ₄ Biogas	
BU	H ₂ S Biogas	
BV	Pressure Biogas	
BW	last column	0

* converted to unit (column AC) and converted on O₂ ref. (Column AB) when column AD = N