

INTELLIGENT MESSEN!
MEASURE WITH INTELLIGENCE!

ecom®



Operating Instructions

ecom® J2KN^{pro} TECH

Index	Page
Important hints	4
1. Instrument design	
1.1. Basic module	6
1.2. Control module	7
2. Gas flow scheme	8
3. 2-stage Peltier cooler	9
4. Heated sampling system	10
5. Converter (option)	11
6. Power supply	13
7. Radio communication basic/control module	14
8. Data record	15
9. Starting	16
10. Input or selection of combustion plants	18
11. Flue gas analysis	
11.1. Gas analysis	21
11.2. Flow measurement (option)	25
11.3. Pressure measurement (option)	26
11.4. Soot dot...Oil trace (option)	27
11.5. Measurement record and printout	29
11.6. Mean value measurement	30
11.6. After measurement	32
12. Adjustments	33
13. Control	39
14. Data processing	
14.1. Communication	40
14.2. Automatic Measurement	41
14.3. Data logger	42
14.4. Data logging with DASNT2	43
14.5. Data processing with DAS5	43
14.6. Data processing with App	44
15. Diagnostics	
15.1. Fault diagnostic	45
15.2. dT-measurement	47
16. Maintenance tips	48
17. Technical data	52
18. FAQ	53

Congratulations!

With your purchase you have decided on a high-quality product of ecom GmbH.

Get to know the product before you start using it while reading carefully the following instructions of use and the safety indications. Use the product only as described and only for the given areas of application in order to ascertain its longevity.

Important hints



Please connect flue gas hose to flue gas duct before starting!

To exclude any risk to persons, it is necessary to connect the sample gas outlet (TOXIC GAS) of the instrument with the flue gas hose to the flue gas duct.

Please confirm after successful connection the security message at the instrument with **<OK>**.

Security message:

Please confirm (OK) before starting, that the sample gas outlet (TOXIC GAS) has been connected through the flue gas hose to the flue gas duct!

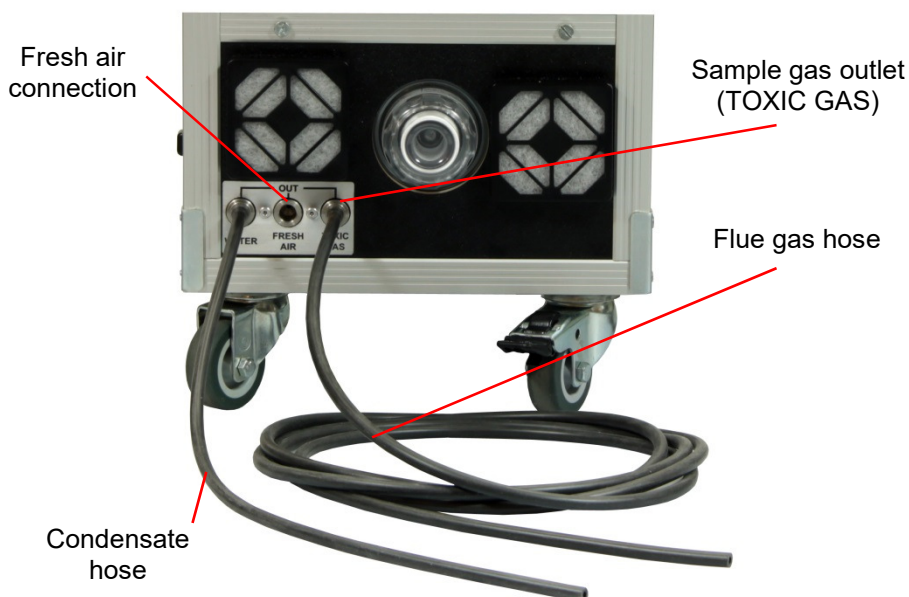



**Before starting connect the condensate hose
(possibly collect condensate in a vessel)!**



**To ensure sufficient airflow, a minimum distance
of 0.5 m must be kept to walls or objects!**



**Adjustments at burners and boilers should be
made only by specialists, who are familiar
with this installations!**

1. Instrument design

1.1. Basic module

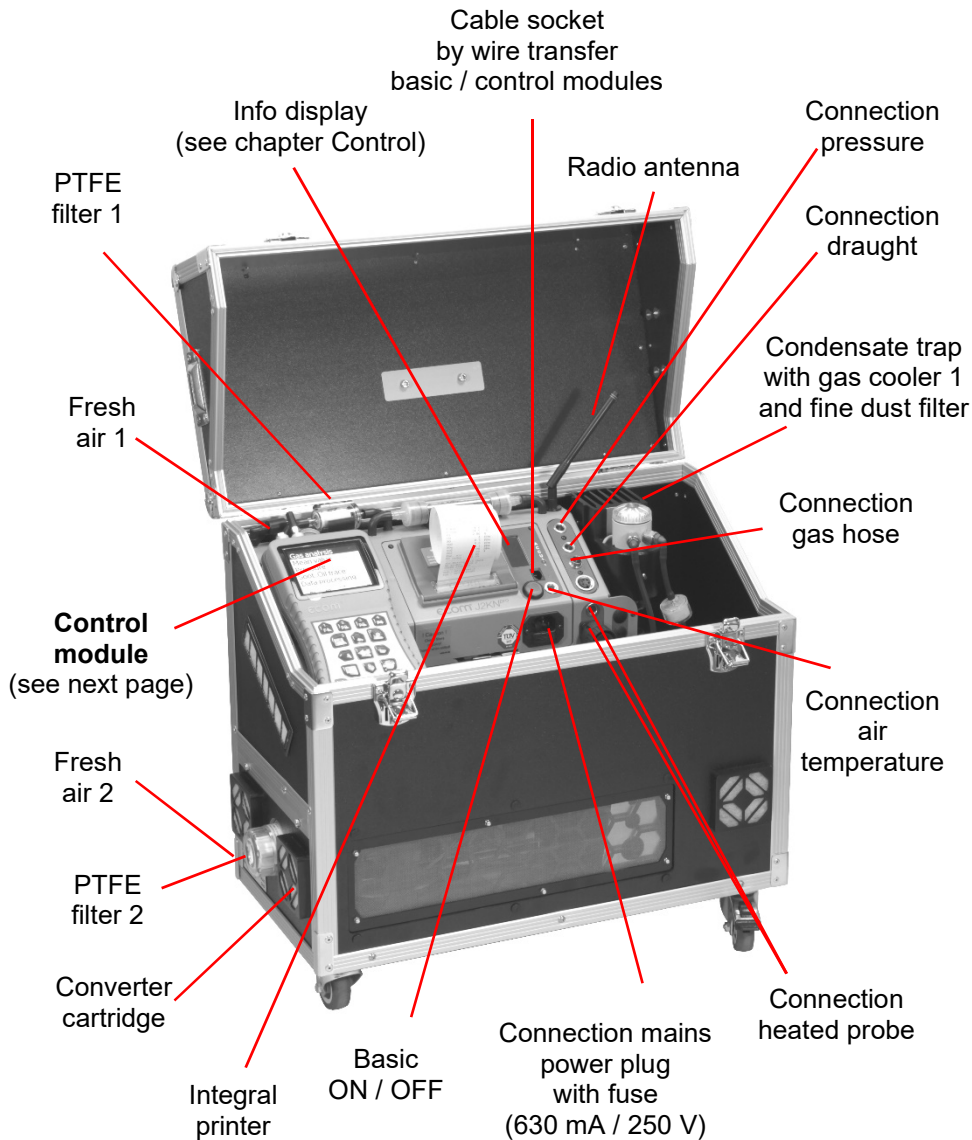

1.2. Control module

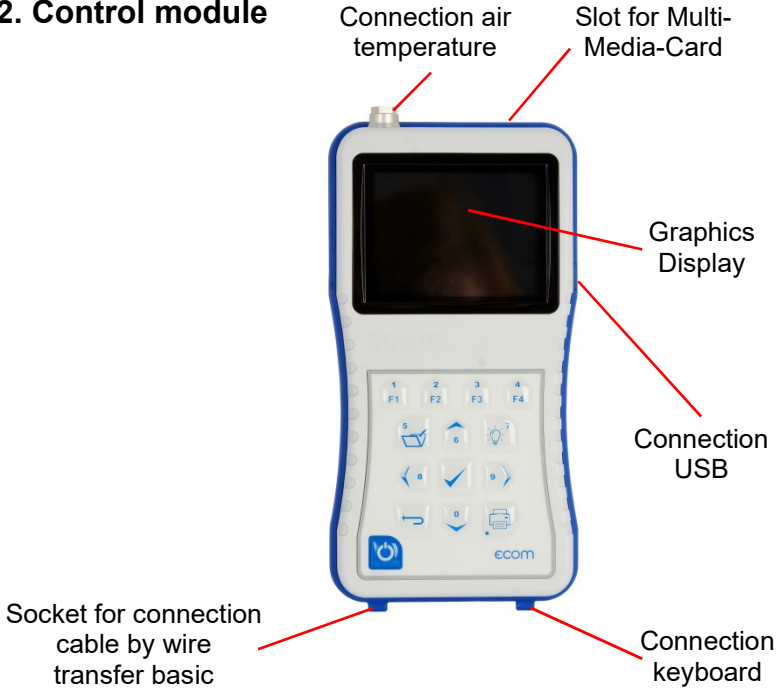

Function keys
(function shown on display)

Measurement values recording

Display backlit ON/OFF

Cursor keys
(Up/Down/Right/Left/Scroll)

OK key
(confirm selection)

ESC key
(quit/escape menu)

Print key
(access to printing menu)

Switch ON/OFF control module

In the input mode, the keys are used for numerical inputs

2. Gas flow scheme

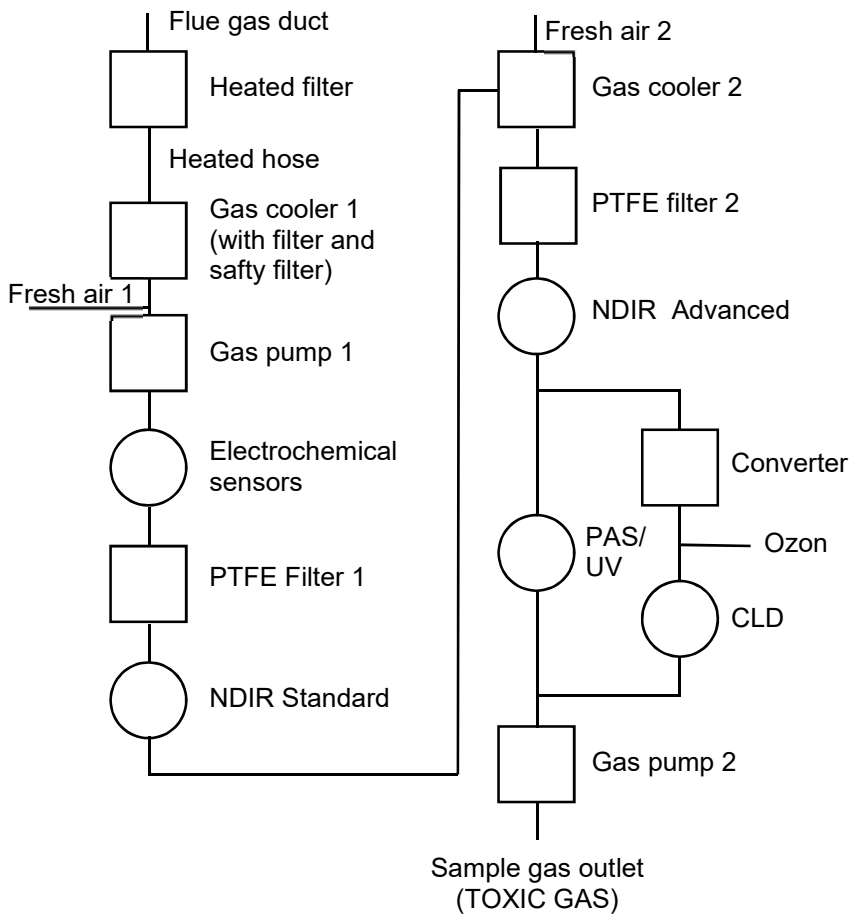

3. 2-stage Peltier cooler

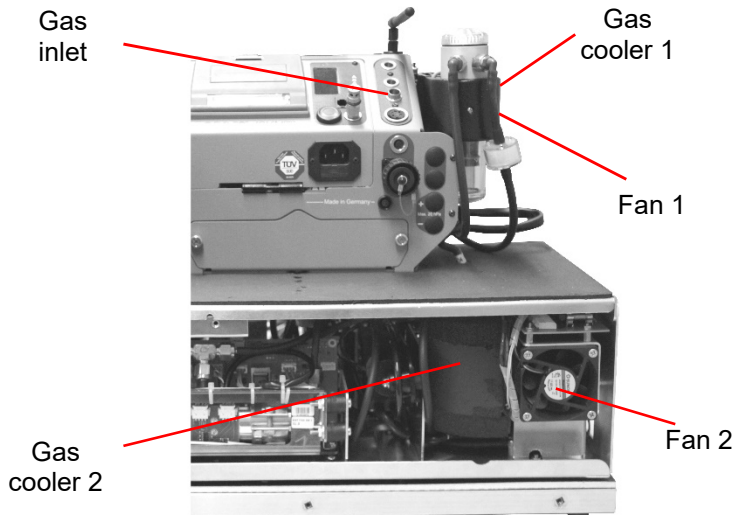

Flue gas with a temperature above the dew point is sucked spiral via a long gas path through a surface-coated metal body with good thermal conductivity. The gas radiates its heat to this metal body. A Peltier element (semiconductor cooling element) powered by a continuous current is thermally connected with this body and with a second metal body with cooling ribs and ventilation slots. The current through the Peltier element creates a heat transfer from hot to cold, drains the heat of the metal body from the gas and transfers it to the outer cooling body. This heat is transferred through ventilation to the surrounding air.

The condensation caused by the heat loss of the gas drops in a receptacle and is pumped out by a permanent working hose pump. The sucking capacity of the gas conveying pump avoids a sufficient dwell time of the gas with the condensate, so that wash-out reactions ($\text{NO}_2 + \text{H}_2\text{O} > \text{H}_2\text{NO}_3$) do not take place. At the cooler outlet, the gas has a temperature of ca. 5 °C with a relative saturation of nearly 100% relative humidity (corresponds to a water steam content $< 7 \text{ g/m}^3$).

4. Heated sampling system



Heated sampling system

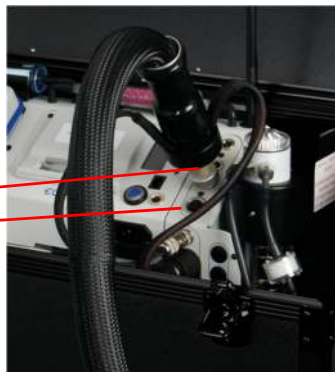

Direct connection at the front of the J2KNpro TECH



Please note:

- Do not bend the tube
- Heated tube has to be cooled out after the measurement
- Heated tube may not be folded too tight (use the whole under case)
- Do not put the heated tube in water
- Clean or replace PTFE filter regularly

By using a heated sampling system (option) is possible to measure water-soluble substances (NO_2 and SO_2) without washout. A built-in hot gas filter protects the instrument especially for long-term measurements from fouling. The maximum exhaust gas temperature when using the heated sampling system is 500°C .

5. Converter (option)

The NO₂ / NO Converter converts catalytically the NO₂ content of the sample gas into NO. For this purpose, the sample gas is passed through a converter cartridge from stainless steel having a catalyst filling. This conversion allows an indirect measurement of NO₂ (switch function key <F1> at the control unit to toggle between NO and NO_x measurement).

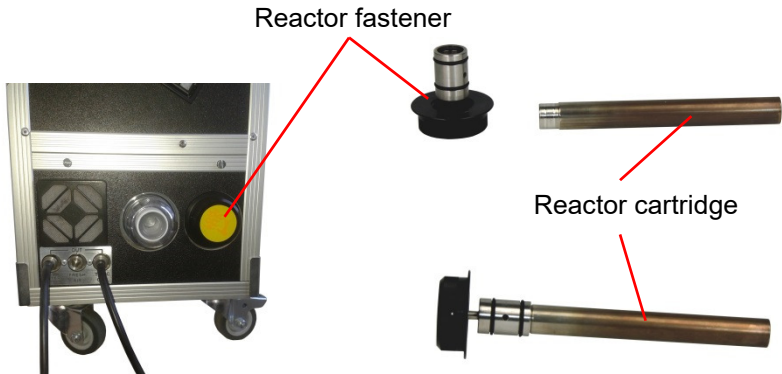

Replace reactor cartridge:



The converter cartridge is hot! Touching may cause severe burns! Wear suitable protective gloves and protect the converter cartridge against access!

Replace the reactor cartridge if the conversion rate from NO₂ => NO falls below the required value. Changing the reactor cartridge is possible without tools in a very short time. We recommend turning off the instrument and letting cool down for approximately 1 hour before changing the cartridge. This minimizes the hazard of burning. There is also the possibility of changing cartridges in a heated instrument, but the converter cartridge has a temperature of about 200 ° C.

How to change the reactor cartridge:



Use only spare parts and consumables from ecom!

- Stop sample gas flow (deactivate NOx measurement).
- Before opening the reactor fastener make sure that no toxic or dangerous gases or components are provided within the gas way. (Purge the tubes with inert gas or air).
- Turn the reactor fastener counter anticlockwise up to the end of the thread.
- Pull out the fastener with the reactor cartridge carefully.
- Let the cartridge cool down if needed.
- Pull the reactor cartridge out carefully from the reactor fastener (wear protective gloves).
- Replace new reactor cartridge to the reactor fastener.
- Push the cartridge carefully to the reactor opening and turn the reactor fastener clockwise up to the end of the thread.

6. Power supply



Used accumulators can be returned to us or brought to recycling stations of public waste disposal companies respectively accumulators selling stores!

The basic module of the ecom-J2KN^{pro} TECH is delivered with internal loading unit. The connection of the power plug is needed to operate the instrument.



Never use batteries, to operate the control module of the ecom-J2KN^{pro} TECH!

The control module of ecom-J2KN^{pro} TECH is powered by 3 nickel-metal-hydride accumulators (type AA). In case of need, the accumulators can be recharged by docking the control module to the basic module.

7. Radio communication basic / control module

Thanks to the detachable control module the basic module can be monitored wireless. The basic module can be unlocked as follows:

1. Press to unlock.
2. Tip control module forwards
3. Release control module from basic module

The information exchange between control and basic module is performed via radio transmission (868 MHz) with coverage of approx. 70 m (by free sight). The quality of the radio transmission is documented by a bar indication in the main menu of the instrument (long bar = good radio communication).

By interruption of the radio communication, an error message is displayed. By persisting disturbances of the radio communication, a cable (option) can take over the transfer (connection between socket DATA on control unit and socket DATA on basic module).

If the basic module is switched off and the control module not, so the display will show an error message inviting to fix the control module in its docking station (helps also not to forget the control module). Observe this order, quit with **<ESC>** and finally switch off the control module.

Unlocking

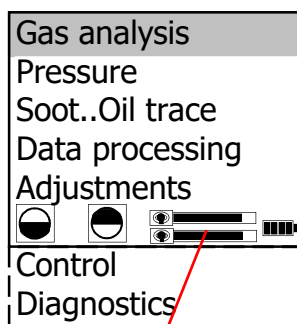

Bar indication
radio quality

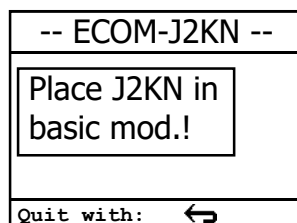
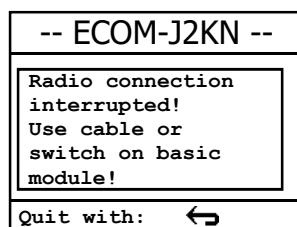

8. Data record

The multi-media card enables the storage of both punctual measurements and data logger records.

The values of punctual measurements are written in a text file (J2KDV.txt). Those of data logger records in a csv file (J2KDL-xx.csv / xx = records numbered consecutively).

Both file types have the same structure and can be imported respectively opened in Excel. See chapter „Technical Data“ for data format information. The files can be transferred on the PC using a card reader. The following conditions must be fulfilled for using a multi-media card:

- ecom-J2KN^{pro} TECH
- min. card volume 32 MB - max.32 GB (UHC)
- card formatted on 16 bit FAT or FAT32
- SD cards from SanDisk recommended
- PC with card reader

Insert the multi-media card as shown. Take care that the card does not stand out and hooks on.



Never pull out cards during data record - data loss and damaging of the data carrier possible!

9. Starting



Before starting up please remove the transport protection!

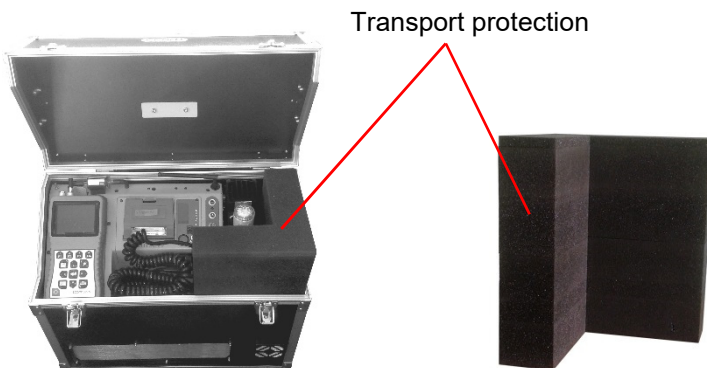

Once the control module has been switched on (key <I/O>), the main menu is displayed.

8 sub-menus with the following functions are displayed (non-visible sub-menus can be called up scrolling the arrow keys):

Display contrast adjustable with F1 and F2

Gas analysis

Mean value

Pressure

Soot..Oil trace

Data processing









Adjustments

Control

Diagnostics

Bar indication radio quality

Battery voltage (charging status)

Bar indication transfer quality

- Gas analysis : Perform gas analysis
- Mean value : Measurement with mean value calculation
- Pressure : Perform draught or pressure measurement
- Soot...Oil trace : Input of soot measurements results
- Data processing : Assign measurements / Load or send data
- Adjustments : Modify instrument adjustments
- Control : Check operation state of instrument
- Diagnosis : Read-out of firing automats
(only in connection with ecom-AK) /
dT-measurement



Make sure that the instrument is turned on in clean air, because the zero point of the sensors will be updated with fresh air!

If measurements are carried out first the basic module has to be turned on (switch below the info display). Select the sub-menu **"Gas analysis"** with the cursor keys and confirm with **<OK>**. The instrument starts with a warm-up phase (max. 30 min.). After the sensors are at operating temperature, a 15-minute stabilization phase follows followed by a 3-minute calibration with fresh air. Simultaneously, the message appears asking if you want to use the data processing. If you want to assign the sampled data to a specific plant, so press **<F1>** (**<F4>** = no: measurement will be performed without assignment).

Fuel types acc. to 1st BImSchV*:

- Fuel oil (B)
- Natural gas (B)
- City gas (B)
- Coke oven gas (B)
- Liquid gas (B)

Do you wish to use the data processing?

Quit with !

Use the cursor keys to select the desired fuel type and confirm with **<OK>**.

** Country specific fuel types programmable on demand.*

Fuel type		
Fuel oil (B)		
CO2max	A1	B
15.4	0.50	0.007
Select:	<input type="button" value="⏮"/>	

10. Input or select plant specific data

To call up plant data recorded in the **ecom-J2KN^{pro}** or to create a new file, the following possibilities are available:

Create new (is automatically selected by first use of a MM card): To create a new file, a numerical number can be assigned.

- Select „**Create new**“
- Confirm with **<OK>**.
- Input a number (max. 16 numbers):

Example: "25.11.2017"

Selection upon:	
Search word	
Memory number	
Create new	
Quit with: 	





Input number
25.11.2017
Please use the numeral keys!

Tip: We suggest a date-related input to easily find the data record later on via the search function (search per date).

After confirming with **<OK>** it is possible to enter a text (max. 6 lines with 20 indications) with a software keyboard (for print out or data processing). Proceed as follows:

- choose Text line 1 with the cursor keys **<up/down>** and confirm with **<OK>**
- select keyboard (4 keyboards are available) with **<F3>**
- select with the cursor keys **<up/down/right/left>** a character (selected character is black deposited)
- choose the character with **<OK>** (the last character can be deleted by pressing **<F2>**)
- repeat procedure, until line is complete
- if you want to correct a character, proceed as follows:
 - interrupt choosing characters with **<F4>**
 - select character with the cursor keys **<right/left>**
 - activate choosing characters with **<F4>** and set a new character
- select the next line after pressing **<F1>**

You can close the text input with **<ESC>**. Activate the next free record number with **<OK>** and start flue gas measurement with **<F1>**.

Insert Text
25.11
A B C D E F G H I J K L M N O P Q R S T U V W X Y Z À Ö Ü . - () [] { }
   

Record number: For check of the plant already stored in the instrument, the selection upon record number is most appropriate.

- Select „**Record number**“
- Confirm with **<OK>**.
- Input a random record number:

Example: "1" for record number 1

Selection upon:
Search word
Memory number
Create new
Quit with: 

Memory number	
<table border="1"> <tr> <td>1</td> </tr> </table>	1
1	
Please use the numeral keys!	

- Press **<OK>** once the input is completed to call up said data record number. The cursor keys **<Up/Down>** enable the check of the record numbers.
- Press **<F1>** to select the first record number and **<F2>** for the last.
- Press **<F4>** to delete the content of the selected record number.
- Press **<OK>** to activate the record number.
- Finally press **<F1>** to start the gas analysis.

Search word: If the plant code is known, it is possible to find the plant data stored with help of a search machine.

-Select "**Search word**" and press **<OK>**.

-Input with software keyboard 4 related figures of the plant code:

Example: "25.11"
for plant code 25.11.2017

-Press **<F1>** after input to start the searching process. All possible correspondences with these figures sequence will be filtered. The selection can be stepped thru with the arrow keys (**<F1>** for selection beginning, **<F2>** for selection end)

-Press **<OK>** to activate once the desired data block is found

-Press / „**View**“ / **<OK>** to view the previous analysis at this plant

Search word												
25.11												
A	B	C	D	E	F	G	H	I	J	K	L	M
N	O	P	Q	R	S	T	U	V	W	X	Y	Z
Ä	Ö	Ü	.	-	()	[]	{	}		
<input checked="" type="checkbox"/>	<input type="checkbox"/>	<input type="checkbox"/>	<input type="checkbox"/>	<input type="checkbox"/>	<input type="checkbox"/>	<input type="checkbox"/>	<input type="checkbox"/>	<input type="checkbox"/>	<input type="checkbox"/>	<input type="checkbox"/>	<input type="checkbox"/>	<input type="checkbox"/>

Memory number 1			
25.11.2017			
F1:First record F2:Last record F4:Delete			
End with : <input checked="" type="checkbox"/> !			

Measurement available

All measured and calculated values can be called up on 4 display pages using the arrow keys to step thru.

Memory number 1 25.11.2007 Data record 12:15:53 25.11.17 Further pages:<↑↓> Memory number 1	O2 3.2 % CO2 13.1 % CO 0 ppm Eff. 92.5 % Losses 7.5 % Exc. air 1.18 T.Gas 184.4 °C T.Air 20.3 °C Draught -0.03 hPa Gas analysis 12:15:53 25.11.17 Further pages:<↑↓> Memory number 1	O2 17.5 % CO 0% 738 ppm CO 123 ppm Lambda 7.00 CO measurement 12:15:53 25.11.17 Further pages:<↑↓> Memory number 1
O2 value in air o2 19.5 % CO 3 ppm Zug 0.01 hPa O2 value in air 12:15:53 25.11.17 Further pages:<↑↓> Memory number 1	Soot..Oil trace Boiler temp. : 65°C 1st Soot meas. : 0.5 2nd Soot meas. : 0.3 3rd Soot meas. : 0.7 Oil trace : NEIN Mean value : 0.5	dT measurement T1 70.4 °C T2 56.3 °C dT 14.1 °C dT measurement 12:15:53 25.11.17 Further pages:<↑↓> Memory number 1

Press **<F1>** to quit the previous measurement and start recording of the current measurement values.

11. Flue gas analysis

11.1. Gas analysis



To compensate a possible sensor drift, it is important to calibrate the instrument with fresh air at regular intervals!

After warm-up and calibration phase, the instrument switches over to the measurement mode. The gas measurement values can be viewed on different display pages. Use the cursor keys to scroll the pages.

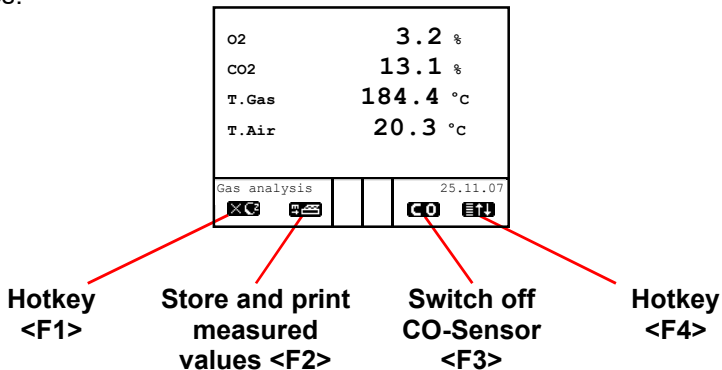

With <F1> you can switch from the measured value display to a menu or selected before (see chapter Adjustments). Possible menu options are: Soot... Oil trace, Data processing, Adjustments, Control, Fuel type, Standby, Purge, Eff. (C), Memory -> M, CLD NO <-> NO_x, WLAN, Pressure. Further you can switch with <F1> from any menu back to the measured value display.

With <F2> you can print and store the measured values into the intermediate memory at the same time.

With <F3> you can switch off the CO sensor, in order to protect the sensor against too high concentrations (only required for electrochemical CO sensor). The automatic disconnection will switch off the CO sensor at approx. 2500 ppm (also for CO IR).

With <F4> you can switch from the measured value display to a menu selected before (see chapter Adjustments). Possible menu options are: Soot... Oil trace, Data processing, Adjustments, Control, Fuel type, Standby, Purge, Eff. (C), Memory -> M, CLD NO <-> NO_x,

WLAN, Display values, Pressure. Further you can switch with **<F1>** from any menu back to the measured value display.

The position of the measured and calculated values (gas analysis) on the display pages is free selectable (choose „**Display values**“ for **<F4>** Hotkey). For alteration of the existing succession respectively personal listing, proceed as follows:

- Press **<F4>** to activate the function.
 - select the line with the cursor keys **<up/down>**,
 - select the measured or calculated value with the cursor keys **<right/left>**,
 - repeat this procedure until all modifications are completed.
- Press **<F4>** to deactivate the function.

Instruments with magnetic valve and fresh air connection

Instruments that are equipped with magnetic valve technology and fresh air connection are able to be purged or calibrated with fresh air without taken out the probe out of the flue gas duct:

For fresh air purging, press the **<Enter>** key from the measured value display, select the menu item **"Fresh air purge"** and press the **<Enter>** key again. The fresh air purging can be ended with **<F3>** in the measured value display.

For fresh air calibration, press the **<Enter>** key from the measured value display, select the menu item **"Re-Calibration"** and press the **<Enter>** key again. After the following query has been answered with **"YES"** (**<F1>**), the 1-minute calibration phase starts.

Core stream search

Position the sampling probe in the exhaust channel so that the thermocouple is fully surrounded with the gas.

Perform the measurement in the core stream of the exhaust gas channel (probe placed in the highest gas temperature area).

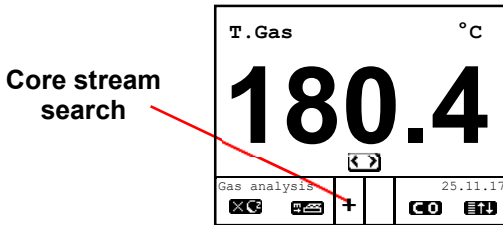

Zoom Display:
Adjust parameter
with Cursor keys
<right/left>

A trend indication for T.Gas eases the core stream search. As long as the display shows a + symbol, the measured temperature increases, it means the probe tip moves towards the core stream. If a - symbol is displayed, pull the probe out of the core stream and the temperature sinks. If no temperature change is shown for at least 3 seconds, so the trend indication will be deleted.

CO₂, efficiency, losses, excess air and dew point are calculated values. They can only be calculated if realistic values for the basic parameters O₂ and temperatures are available. It must be ascertained that:

$$\text{O}_2 < 20,5 \% \quad \text{and} \quad \text{T.Gas} - \text{T.Air} > + 5 \text{ } ^\circ\text{C}$$

are given. The dew point can only be calculated accurately if, in the menu "**Adjustments**", the current barometric air pressure value has been entered. This value cannot be determined by the **ecom-J2KN^{pro}**. If the gas temperature falls below the dew point (between 25 and 65 °C), ETA will be calculated with condensation. In the display (C) appears behind ETA.

Correct measurement values are displayed first after a short delay, necessary for the gas transport and the build-up of a stable electrochemical reaction at the sensors. This time period lasts approx. between 1 and 1.5 minute. For recording, printout and evaluation wait until the values do not change anymore. If deviations higher than 2 ppm still occur by the gas values, they can be due to unstable pressure conditions in the exhaust channel.

If the measurement values are stable and the results can be printed out, press the key **<Record>** (disc symbol) to transfer the values in the intermediate memory (caution: store gas analysis and CO measurement values separately). The values are stored for a later printout and, if need be, for a final data record storage.

O ₂	3.2	%
CO ₂	13.1	%
T.Gas	184.4	°C
T.Air	20.3	°C
Gas analysis recorded!		25.11.17



Measurement stored in intermediate memory

If a printout of the values should be made simultaneously to the intermediate recording, so press **<F2>** (the complete content of the intermediate memory will be printed).

11.2. Flow measurement (option)

This measurement can be done with a pitot tube. At first the pitot factor of the pitot tube must be entered („Adjustments“ / „Internal“ / „Pitot factor“). After connecting the pitot tube to the instrument, the zero point of the sensor can be set with <F4>. With <F1> the cross section of the flow channel can be entered (needed for calculation of the flow rate). After the pitot tube is positioned in the flow channel, the display shows the speed (m/s), the flow rate (Nm³/h) and the differential pressure (Pa). If the value indicated is stable, press <Record> to store the value in the intermediate memory. If a printout of the values should occur simultaneously to the recording in the intermediate memory, press <F2> (the complete content of the intermediate memory will be printed out).

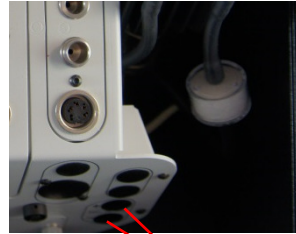

Connections for pitot tube

Flow measurement	
V. Gas	0.4 m/sec
M. Flow	44 Nm ³ /h
dP	0.1 Pa
Flow measur. recorded!	25.11.17

Measurement stored in intermediate memory

11.3. Pressure measurement (option)



For this option a probe type SB is required!

A trend indication for the draught conditions in the exhaust channel can already be determined during the gas analysis. Nevertheless the value for the chimney draught will not be stored together with the gas values while pressing the key **<Memory>**.

Indeed the difference pressure sensor tends to drifts because of its sensibility and, for an exact measurement it is consequently advised to re-calibrate the sensor immediately before sampling and documenting the value.

Access the menu while selecting the sub-menu **"Pressure"**. The current value is displayed as well as the instruction to adjust the zero point of the sensor. Release hereto the draught hose from the instrument for a short moment and press **<F4>**. The sensor is herewith re-calibrated.

Fix the draught hose again. The display shows the exact measurement value which can be stored while pressing **<Memory>** and added to the previous results in the intermediate memory. The stored value is shown on the display. Press **<ESC>** to quit the differential pressure measurement menu.

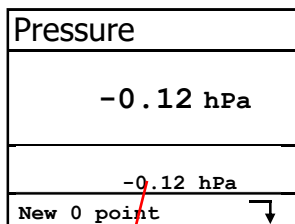
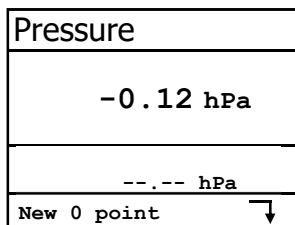

Measurement stored in intermediate memory

11.4. Soot...Oil trace (option)



For this option a probe type SB is required!

The sub-menu "**Soot...Oil trace**" enables the input of measured results for boiler temperature, soot dots and oil trace. Select the line „**Boiler temp.**“ and press **<OK>** to activate the input. The input can be made using the numerical keys. Press **<OK>** to store the value in the data record of the measurement.

Soot..Oil trace	
Boiler temp.:	66°C
1st Soot meas.:	.-
2nd Soot meas.:	.-
3rd Soot meas.:	.-
Oil trace :	----
Mean value:	.-

The soot dot measurement is to be performed with the optional heated pistol grip probe which heating function prevents the filter paper to become wet because of the humidity issued by the combustion condensate. The filter paper slot is hereby heated up to approx. 70 °C. Switch hereto the probe heating of the pistol grip probe while selecting „**Adjustments / Internal / Probe heating / <F1>**“.

Proceed as follows:

- Switch on the probe heating while selecting „**Adjustments / Probe heating / <F1>**“.
- Insert a filter paper in the paper slot.
- Select the line „**1st. Soot meas.**“.
- Press **<OK>** to start the measurement. The display shows the volume to be sucked and the pump starts sampling.

If the soot dot analysis are made with a manual pump the sucking procedure can be interrupted while pressing **<F4>** (result value can immediately be entered).

Once 1,63 litres has been sucked in, the instrument will instruct to input the opacity degree. Proceed as follows:

- Release the filter paper from the probe slot.
- Compare the greyness with the opacity scale.

- Input the result using the numerical keys and press **<OK>**.
- Repeat this procedure until all 3 soot dot analyses are completed. The mean value will be calculated and automatically stored.

The result of the oil trace check is to be documented as follows:

- Set the cursor on the line **"Oil trace"**.
- Input the result with **<OK>**
(**"NO"**, **"YES"** or **"- - -"**)

Soot..Oil trace	
Boiler temp.:	66°C
1st Soot meas.:	1.0
2nd Soot meas.:	0.5
3rd Soot meas.:	1.5
Oil trace :	NO
Mean value:	1.0

- Press **<ESC>** to quit the menu once all necessitated inputs have been entered. The measurement is now completed.



Get the probe cooled down before putting it back in its fixation!

11.5. Measurement record and printout



Once the gas analysis is completed, transfer the values recorded in the intermediate memory to the **Multi-Media-Card** otherwise they could get lost by switch-off of the instrument!

Press **<Print>** (printer symbol) to enter the printing menu. The sampled data can be checked one more time („**View memory**“, **<OK>** and scroll with the cursor keys).

The software keyboard enables the input or correction of the 6 x 20-character text. Select hereto „**Input text**“, press **<OK>** and input text (see page 13).

Press „**Memory -> M**“ and **<OK>** to store the all data -if correct- in the internal memory or on the multi-media card. Once the transfer is completed, a "**Memory symbol**" appears on the bottom right of the display. The entered text will only be recorded in the data record by use of the multi-media card.

Select „**Start printout**“ and press **<OK>**) to start a printout.

Press **<ESC>** to turn back to the gas analysis menu.

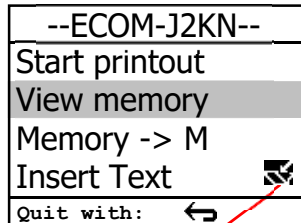
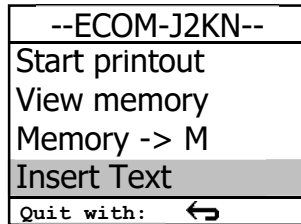
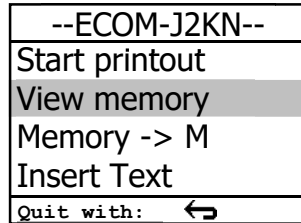

Memory symbol

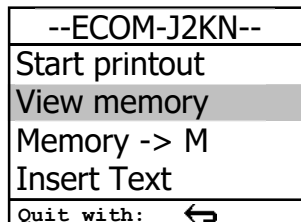

11.6. Mean value measurement

By mean value measurement function measurements can be taken in an adjustable time frame and mean values can be calculated. Should the several measurement values or the mean value result be stored a storage place has to be selected as described in chapter 7. If the function “**Store**” is activated, based on this storage place all measurements will be written consecutively on the next storage places. If the function “**Store**” is not activated, the mean value result can be stored on MMC with **<Print> / „Memory -> M**.

After run through fresh air calibration the menu point “**Mean value**” can be chosen. Before the mean value measurement can be started the settings for “**Meas.time**”, “**Scanning**”, “**Printer**” and “**Storage**” should be checked and if necessary be changed. The meanings are:

-**Meas. time** = Time frame in which the mean values will be calculated

-**Scanning** = time between the measurements taken for mean value calculation

-**Printer** = logging of measurements taken for mean value calculation

-**Store** = all measurements for mean value calculations will be stored

Gas analysis
Mean value
Pressure
Soot..Oil trace
Data processing
Adjustments
Control
Diagnostics

Mean value
Start measurement
Meas. time
Scanning
Printer
Store
Quit with: ←

“**Measurement time**” and “**Scanning**” can be adjusted as follows:

-select menu point and confirm with **<OK>**

-with the numeric keys set the desired time:

0.01 = 1 sec. = minimum value

59.59 = 59 min and 59 sec. = maximum value

-confirm with **<OK>**

The setting for “**Printer**” can be changed as follows:

- select menu point and confirm with **<OK>**
- select desired setting with the cursor keys
- confirm with **<OK>**

The setting for “**Store**” can be changed as follows:

- select menu point and confirm with **<OK>**
- activate storage function with **<F1>**
- deactivate storage function with **<F4>**

By ‘**Start measurement**’ / **<OK>** the evaluation of the measurement values will be started. On the display the actual mean values will be shown (will be updated with new measurement values / switch to the actual values with cursor keys **<up/down>**). It is possible to scroll through the values with the cursor keys **<right/left>**. With **<F2>** you can interrupt and with **<F4>** stop the measurement.

O2	3.2 %
CO2	13.1 %
CO	0 ppm
Eff.	92.5 %
Losses	7.5 %
Exc. air	1.18
T.Gas	184.4 °C
T.Air	20.3 °C
Mean value	25.11.17
15:59 min	

After finishing the measurement time a protocol of the results with all mean values can be printed (key **<Print>**).

11.7. After measurement



Get the heated sampling system cooled down before putting it back in its case!

Heated sampling system



Fold radio antenna before closing the case!

Radio antenna

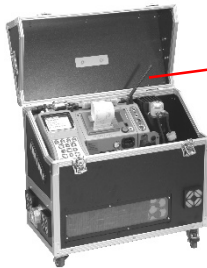

Please place transport protection before transport!

Transport protection

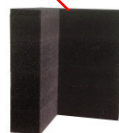

12. Adjustments

Additionally to the ecom-J2KN^{pro} TECH functions described previously, various adjustments can be made in the instrument.

From the main menu select the sub-menu "**Adjustments**" and confirm with **<OK>**. A selection of modifiable parameters, adjustable according to the application, is displayed.

Place the cursor on the desired line and press **<OK>** to call up or modify the adjustment.

The modifiable parameters are:

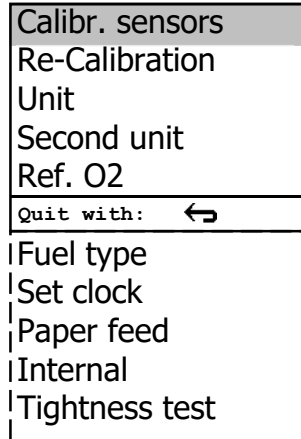

Calibr. sensors:

- Select calibration menu ("**Calibr. sensors**" **<OK>**)
- Choose sensor with cursor keys and confirm with **<OK>**

-CO / NO / NO₂ / SO₂ etc. calibration

(Important: Span gas must get pressure-free to the instrument!)

- Flow with span gas
- Wait for stabilisation of value
- By drift press **<OK>**
- Set correct value with number keys
- Confirm input with **<OK>**

-T. Gas / T. Air calibration

- Create reference temperature
- By drift press **<OK>**
- Set correct value with number keys
- Confirm input with **<OK>**

-Pressure calibration

- Set draught sensor on 0 with **<F4>** key
- Create reference pressure
- By drift press **<OK>**
- Set correct value with number keys
- Confirm input with **<OK>**

-Soot measurement calibration

- Connect suitable reference principle for volume determination
- Insert filter paper
- Confirm with **<OK>**
- Start soot measurement with **<OK>**
- After 1,63 l volume has been sucked, press again **<OK>**
(operation time of the pump will be memorised)

-Press **<ESC>** to return to the main menu

Unit (adjustment with **cursor keys**):

-Calculation of gas concentrations in:

- ppm = volume concentration (parts per million)
- mg/m³ = mass concentration per volume unit
- mg/kWh (undiluted) = mass concentration per power unit
- mg/MJ (undiluted) = mass concentration per power unit
- ppm (undiluted) = volume concentration (parts per million)
- mg/m³ (undiluted) = mass concentration per volume unit

Undiluted:

-Conversion of the gas concentration on selected reference oxygen:

-mg/kWh and mg/MJ are always calculated on 0% O₂ basis

-Conversion formula:

$$E_{\text{ref}} = E_{\text{meas}} * \frac{21 - O_{2\text{ref}}}{21 - O_{2\text{meas}}}$$

Second unit (adjustment with **cursor keys**):

-two different unit for one gas concentration possible

Ref. O₂

(for ppm and mg/m³ units - Input after **<OK>** pressing):

-Input of O₂ reference value O_{2ref}

Fuel type (press **<OK>** to access selection list):

-Modification of adjusted fuel type (e.g. by measurements at combination plants)

Set clock (press **<OK>** to access setting menu):

-Correction of internal clock with cursor keys

Paper feed (press **<OK>** to activate paper feeding):

-Paper feed line by line

Tightness test (Start with **<OK>**):

-Leakage test of gas system of the ecom-J2KN^{pro} TECH

-Lock probe with a plug and start test with **<OK>**

Internal (press **<OK>** to open menu):

-Further instrument settings:

Printout contrast (0..9)

(press **<OK>** to access input menu):

-Printer contrast adjustment

Recharging function

(**<F1>** for ON / **<F4>** for OFF):

-Recommended setting = OFF

Key beep (**<F1>** for ON / **<F4>** for OFF):

-Acoustical signal by key pressing

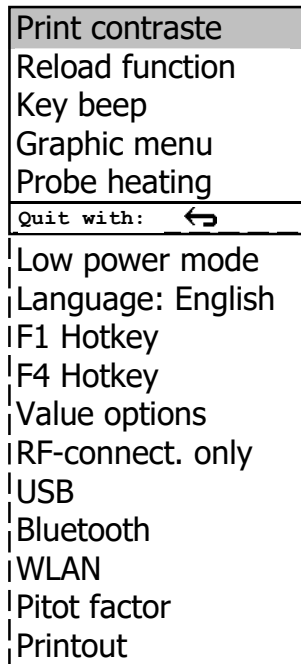

Graphic menu (<F1> for ON / <F4> for OFF):

-Activation of graphic mode

Low power mode (<F1> for ON / <F4> for OFF):

-Switching on / off the probe heating and the gas cooler at battery operation

Probe heating (<F1> for ON / <F4> for OFF):

-ON/OFF switch for probe heating for soot measurement

Language: English

-Info about language (3 languages selectable)

F1 Hotkey (Choose after pressing <OK>):

-Change the menu you get to after pressing <F1> in value display

F4 Hotkey (Choose after pressing <OK>):

-Change the menu you get to after pressing <F4> in value display

Value options (Change with <OK>):

-Temperature in °C or °F (not possible at all instruments)

-Excess Air as proportionate number or in %

-Calculation of efficiency with and without condensation

-Pressure in hPa, mmH₂O, "H₂O, PSI, mbar

(not possible at all instruments)

RF-connect. only (Choose after pressing <OK>):

-**Standard**: no radio connection if control module is located in basic module

-**RF-connect. only**: radio connection also if control module is located in basic module

-**Remote**: without function

USB (selection after pressing <OK>):

-Adjustment of transfer speed (Cursor keys <Up/Down>) and Protocol (Cursor keys <Right/Left>) for the USB interface (connection USB):

-Protocol DAS = Protocol for the program DASNT

-Protocol Enhanced = Protocol for the program DAS5

Bluetooth LE (<BLE> no adjustment needed):

-Online data = Remote

WLAN (selection after pressing <OK>)

Instrument as Access Point (for connection with mobile terminals):

-**(Start/Stop WLAN:** manual switching of WLAN connection

– available only with deactivated Auto Connect)

-**Access Point:** (<F1> for ON / <F4> for OFF)

-**(W.O.) Auto Connect:** Automatically connection

(<F1> for ON / <F4> for OFF)

-**Security:** use password for connection

(<F1> for ON / <F4> for OFF)

the password is „1234567890“

-**Channel:** Input channel (1 – 13)

(selection after pressing <OK>)

Connection with existing network:

-**(Start/Stop WLAN:** manual switching of WLAN connection

– available only with deactivated Auto Connect)

-**Existing Network:** available only with deactivated Access Point

-**(W.O.) Auto Connect:** Automatically connection

(<F1> for ON / <F4> for OFF)

-**Network scan:** Search for available networks

(selection with <OK>)

-**WPA password:** Input of password for selected network

Pitot factor (selection after pressing <OK>):

-Input of pitot factor for flow rate calculation (ecom flow probe = 0.93). If the flow rate calculation is not needed, set pitot factor to 0

Printout (selection after pressing **<OK>**):

- Text input for printout on measurement protocol (8 x 24 characters)
- Input the text of line 1 as follows:
 1. Activate character selection list with **<OK>**.
 2. Select keyboard type with **<F3>**
(4 different keyboards available).
 3. Use the cursor keys to select the desired character
(selected character is outlined by black background).
 4. Confirm selection while pressing **< OK >**.
 5. Repeat procedure until desired text is complete.
 6. Once input for line 1 is completed, deactivate the characters
selection mode with **<F1>** and move to the second line with the
cursor key **<Down>**.
 7. Once all lines have been processed as desired, exit the menu
with **<ESC>**.

13. Control

The sensors alter their output values along the operation period. The programme controls the sensors and corrects drifts. If the drifts and the correlated measurement errors increase, an error message is displayed. In this case the corresponding sensor must be changed by an authorised service centre. The control menu informs about the current status values for the sensors as well as about (page 2 and 3 with cursor keys **<up/down>**):

Next service centre	Control ecom GmbH Am Großen Teich 2 58640 Iserlohn	C2 10744 mV CO 7 mV Batt 4.50 V Bat.B 6.09 V	Accu voltage control module basic module
Serial number	Tel.: 02371-945-5 Fax: 02371-40305 @Mail: info@ecom.de	Operation hours : 8.45 hrs	Operation hours
Software version	Serial no. : J2KN 12345 Service tel. : 02371-945-5 Program version : V3.0 / 12.07.16 Next unit check : 20.04.17	Recommended maintenance date	Recommended maintenance date
Radio quality	Control	Number of CO-switch -offs	Number of CO-switch -offs
Sent frames (radio)	20 1 X 4.2 /s 22 ppm 4.2 /s 4 X 0.0 /s 11 X	C2 10744 mV CO 7 mV Batt 4.50 V Bat.B 6.09 V	ppm hours of CO sensor
Received frames (radio)	Operation hours : 8.45 hrs Serial no. : J2KN 12345 Service tel. : 02371-945-5 Program version : V3.0 / 12.07.10 Next unit check : 20.04.17	Number of errors	Number of errors
Number of frames (USB)	Control	Number of instrument switch -ons	Number of instrument switch -ons
Date of last service	Last service (history) 19.12.16 133 hrs --.--.--	C2 10744 mV CO 7 mV Batt 4.50 V	

Gas pump is running		2.24	Gas flow (liter per minute)
Air valve is open			
CO purging is running			Radio mode
Gas cooler ready for use			
Heated hose ready for use			
Heated head ready for use			
Sensors ready for use			
Calibration phase		Mains operation (Battery operation not possible)	

14. Data Processing

14.1. Communication

If a MM card is inserted in the slot, so it will be used as record medium. The menu „Data processing“ offers the following functions:

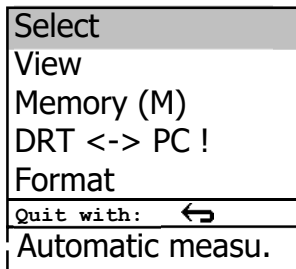

Select:

For search or creation of plants files for measurement values assignment (compare chapter “Input or selection of combustion plants”).

View:

Recorded values to a selected plant can be viewed (compare chapter “Input or selection of combustion plants”).

Memory (M):

Here all stored measurements (sorted by record number) can be seen. Individual measurement values can be called as follows:

- Choose record number with the cursor keys and confirm with <OK>
- Scroll with the cursor keys
- Leave record number with <ESC>

Date	Time	Fuel type	
1	01.09.17	11:01:24	Fuel oil
2	01.09.17	11:02:34	Fuel oil
3	01.09.17	11:04:20	Fuel oil
4	01.09.17	11:07:44	Fuel oil
5	01.09.17	11:11:25	Fuel oil
6	01.09.17	11:23:02	Fuel oil
7	01.09.17	11:44:09	Fuel oil
8	01.09.17	11:53:13	Fuel oil
9	01.09.17	11:59:59	Fuel oil
10	01.09.17	11:59:59	Fuel oil

Select: (up/down arrows)

DRT <-> PC !:

Load data:

Enables the data import with USB cable from e.g. ecom software “miniDV” (available on our website „www.ecom.de“). See chapter „Technical Data“ for data format information (please observe the transfer options of your software!).

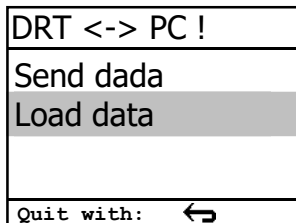

Proceed as follows:

- Connect ecom-J2KN^{PRO} TECH and PC via USB cable.
- Select “**Load data**“ and confirm with **<OK>**.
- Answer the displayed question with **YES (<F1>**).
- Decide if the data recorded can be cancelled (**<F1>** for **YES** / **<F4>** for **NO**).
- Start the data transfer on your PC.

Send data:

With this function the data records completed with measurement values can be transferred to the PC programme (procedure similar to chapter „**Load data**“).

Format:

This function is usually needed by the initial adjustment of the instrument at our factory (preparation of internal memory for data record).

Caution: All stored values will be cancelled!

14.2. Automatic measurement

The configuration of the ecom-J2KN^{PRO} TECH with operation securing, self-regulating additional components like the condense trap, the gas cooler and the magnetic valve technique permits even a long term operation of the instrument. By setting time intervals for the measurement the instrument switches autonomously to fresh air purge after the measurement phase (gas will be sucked via the connection fresh air) and operates a calibration phase for the sensors.

This cycle repeats itself until the automatic measurement will be finished. For setting the time intervals select from the menu “**Data processing**” the menu item “**Automatic measu.**”. The time intervals have following meanings:

Automatic measu.	
Automatic	
Data logger	
Automatic time	120 min
Measur. time	115 min
Save to MMC	1 sek
CSV+Header	
Quit with:	

Automatic time (min. 10 minutes / max. 120 minutes)

Time interval from one calibration phase to the next one.

Measurement time (max. Automatic time minus 5 minutes)

Time interval within the automatic time in which the instrument gather measurement values, i.e. in which the measurement gas will be sucked. The difference between the measurement time and the automatic time is used for purging the sensors with fresh air.

Save to MMC (min. 1 second / max. 255 seconds)

Adjustment of the interval time for data logger recordings.

CSV+Header (<F1> for ON / <F4> for OFF)

Adjustment of data logging with or without column headings.

Start the automatic measurement by setting the cursor to line “**Automatic**” and pressing the key <OK> (on top right on the display appears “**A**” for automatic).

14.3. Data logger

Here a Data logger record (“**Data logger**” and key <OK> / on top right on the display appears the disk symbol) can be started or finished (just available when using the multi-media card). With <Memory> you can interrupt and continue the record (only in gas analysis). For each recording one file will be written on the card. The files will be numbered consecutively (J2KDL-00.csv, J2KDL-01.csv and so on) and can be transferred to PC with a card reader. The length of a dataset is 500 byte which means that on a 32 MB card 64000 measurements could be recorded.

14.4. Data logging with DASNT2

In addition to data logger recordings the data could also be transferred online via USB, Bluetooth (option) or via data interface to the software "**DASNT2**". For the USB connection, a driver is required. Software and USB driver are available free of charge from the ecom website. The following transfer parameters must be set at ecom-J2KNpro TECH ("**Adjustments**" / "**Internal**" / "**USB** "):

- **1200 Baud**
- **Protocol DAS**

Please note the hints in the software manual.

14.5. Data processing with DAS5

To display and storage of measured values and measured value gradients the software "**DAS5**" is available. With the help of a multi-media card customer and measurement data can be exchanged between software and instrument. An online connection to store measured values and measured value gradients is possible with USB or WLAN. For the USB connection, a driver is required. Software and USB driver are available free of charge from the ecom website. The following transfer parameters must be set at ecom-J2KNpro TECH ("**Adjustments**" / "**Internal**" / "**WLAN**"):

- **1200-38400 Baud** (setting as in the software "**DAS5**")
- **Protocol Enhanced**

For the wireless connection (WLAN), the following transfer parameters have to be set at ecom-J2KNpro TECH ("**Adjustments**" / "**Internal**" / "**WLAN**"):

- **Access Point = ON**
- **Auto Connect = ON**

Please note the hints in the software manual.

14.6. Data processing with App

To display and storage of measured values, the App “**ecom connect WiFi**”, “**ecom connect BLE**” or “**ecomMANDER**” for smartphones (iOS or Android) is available. Test results are stored along with customer information in a pdf-file and can be sent f.e. as email attachment. Links to free download of the Apps can be found on the ecom website. For the wireless connection (WLAN), the following transfer parameters must be set at ecom-J2KNpro TECH (“**Adjustments**” / “**Internal**” / “**WLAN**”):

- **Access Point = ON**
- **Auto Connect = ON**

15. Diagnostics

ecom-AK

15.1. Fault diagnostic

The ecom-J2KN^{PRO} TECH is able to receive and to process information sent via cable by the ecom-AK (read-out head for digital firing automats).

In the main menu select the sub-menu "**Fault diagnosis**" and confirm with **<OK>**. The ecom-J2KN^{PRO} TECH tries to get into contact with the **ecom-AK** (message: „Searching“) Once the connection is realized, the current operation stand of the burner is shown graphically on the display. The operation stand can be recorded (max. 100 sec).

Press **<OK>** to start a new recording phase (reset).



Cabel connection to AUX



ecom-J2KN^{PRO} TECH

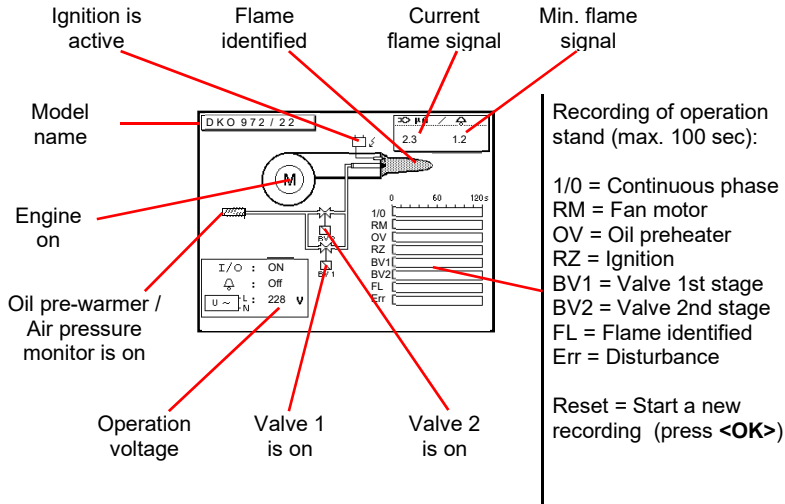

Use the <Up/Down> keys to call up further data of the firing automat. The 2nd display page lists information about the disturbance history (type and volume of information depending on firing automat).

Number of burner starts at a total resp. since reset of firing automat

Error history		
Number of startups total	677	
Service counter actual	142	
No error		
No flame at the end of safety time	004	9:23 min
	0.0 µA	227 V
Flame signal during Straylight check	001	12 sec
	2.2 µA	225 V
Total	: 46	
Straylight	: 22	
Safety time	: 9	
Loss of flame	: 17	
FT/LW	: 0	

Current error

Last 2 errors (Satronic)
Last 5 errors (Siemens)

Error statistics (errors number)

The 3rd display page lists information about the monitoring times (type and volume of information depending).

Monitoring times of firing automat

Timing values	
Safety time	4.9 sec
Delay time valve 2	40.0 sec
Pre-ignition time	17.0 sec
Post-ignition time	20.0 sec
Delay straylight sup.	11.5 sec
Straylight supervision	5.0 sec
Rest time TSA	4.1 sec
Further pages: 	

15.2. dT measurement

With the ecom-J2KN^{pro} TECH a difference temperature measurement is possible. For measurements at pipes (e.g. in and out of heating systems) special temperature sensors are needed, that can be ordered from your responsible ecom distributor. Select from the main menu point "**Diagnostics**" the submenu "**dT measurement**" and confirm with **<OK>**.

The instrument indicates the temperature T1 (sensor at connection „gas temperature“), the temperature T2 (sensor at connection „air temperature“) and the difference of both temperatures (T1 - T2). With the key **<Memory>** the result of the measurement are stored in intermediate memory. A printout can be started with **<Print>**.

dT measurement			
T1		70.4 °C	
T2		56.3 °C	
DT		14.1 °C	
DT-measurement recorded!			25.11.17

Measurement stored in intermediate memory

16. Maintenance tips



Do not use other sensors or feelers from other manufacturers otherwise the TÜV approval will not be valid anymore!

To secure the accuracy of your measuring instrument we recommend the annual check by an authorized ecom partner. All ecom partners are listed under www.ecom.de. The following advices will be of help for the daily check and maintenance of single parts or assemblies:



Service made by service centres not authorised by ecom GmbH will result in a complete and immediate loss of any warranty!

Pre filter heated head

Loosen the bayonet lock (press and turn it 90 °) and check the state of the pre filter. It should be changed when the filter has a grey color (number 2-3 of the soot comparison scale).



Pre filter (PTFE / 2 µm)

Bayonet lock

Fine dust filter

Screw off the cover of the gas cooler 1 and check the state of the fine dust filter. Change it once the filter has a grey colour (number 2-3 of the soot comparison scale).

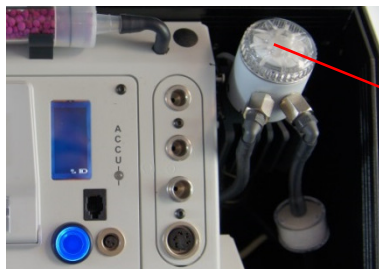

Fine dust filter

Safety filter

Check the state of the safety filter. Change it once the filter has a grey colour (number 2-3 of the soot comparison scale).

**Safety filter****PTFE filter 1**

Check the state of the PTFE filter. Change it once the filter has a grey colour (number 2-3 of the soot comparison scale).

**PTFE filter 1 (20 µm)****PTFE filter 2**

Screw off the cover and check the state of the PTFE filter. Change it once the filter has a grey colour (number 2-3 of the soot comparison scale).

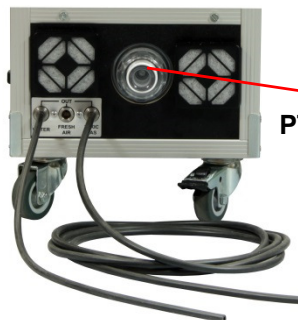
**PTFE filter 2 (2 µm)**

Ventilation filter 1

The ventilation filter should be changed, if the filter is grey coloured (number 2-3 of the soot comparison scale). Remove for this the filter holder with the help of a screw driver (recesses on the right of and left side). Change the filter cartridge and fasten the filter holder.

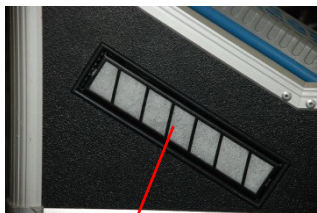

Ventilation filter

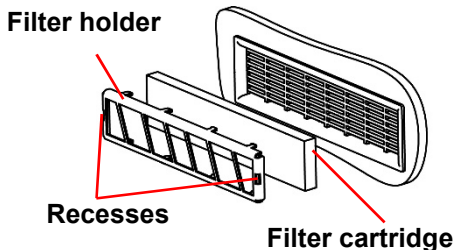

Ventilation filter 2

The ventilation filter should be changed, if the filter is grey colored (number 2-3 of the soot comparison scale). Remove for this the filter holder (pull it off). Change the filter cartridge and fasten the filter holder.



No ventilation filter

Ventilation filter

Sensors

The sensors get calibrated with the reference gas fresh air by each switch-on procedure. The state of the sensors is permanently controlled by the instrument. If an error message is displayed during calibration and cannot be eliminated despite several calibration phases, so the instrument must be checked by a qualified and authorised service centre.

SO₂/NO_x filter (only with electrochemical CO sensor)

In the tubing leading to the electrochemical CO sensor on the top of the instrument there is a chemical filter for filtering SO₂ and NO_x out of the flue gas. The filter material is manganese-4-oxide granules and should be changed once it has turned grey (colour change: pink> brown> black> grey> white).



SO₂/NO_x filter

Probe and hose (only probe type SB)

Depending on the frequency of use, probe and hose should be regularly cleaned in order to release particle deposits and to prevent early wearing due to corrosion:

- Release the connections at the instrument and at the probe grip to free the hose.
- Clean the hose (flow warm water in then dry respectively blow water drops out).

Change printer paper roll

- Release the printer cover.
- If necessary, extract the paper rest out of the printer ("Adjustments" / "Paper feed" / <OK>).
- Remove the printer shaft and place the new paper roll on the printer shaft.
- Insert the paper end in the slot (future printed side must be ahead).
- Press ("Adjustments" / "Paper feed" / <OK>) to transport ± 10 cm paper thru the printer.
- Place the printer shaft back in the fixation.
- Insert the paper thru the cover of the printer compartment.
- Close the printer compartment while fixing the cover.

17. Technical data

Parameter	Range	Principle
O ₂	0 ... 21 vol. %	Electrochemistry
CO (option)	0 ... 1000 ppm	Infrared
CO (option)	0 ... 2500 ppm	Electrochemistry
CO% (option)	2500 ... 63000 ppm	Electrochemistry
NO (option)	0 ... 1000 ppm	Chemiluminescence
NO (option)	0 ... 5000 ppm	Electrochemistry
NO ₂ (option)	0 ... 1000 ppm	Photoacoustic
NO ₂ (option)	0 ... 1000 ppm	Electrochemistry
NO ₂ /SO ₂ (option)	0 ... 100 (2000) ppm	Ultraviolet
SO ₂ (option)	0 ... 1000 ppm	Infrared
SO ₂ (option)	0 ... 5000 ppm	Electrochemistry
H ₂ S (option)	0 ... 1000 ppm	Electrochemistry
H ₂ (option)	0 ... 2000 ppm	Electrochemistry
C _x H _y (option)	0 ... 4 vol. % (CH ₄)	Catalytic
C _x H _y (option)	0 ... 2000 ppm (C ₃ H ₈)	Infrared
C _x H _y (option)	0 ... 30000 ppm (CH ₄)	Infrared
CO% (option)	0 ... 63000 ppm	Infrared
CO ₂ (option)	0 ... 20 vol. %	Infrared
CO ₂	0 ... CO _{2max}	Calculation
Air pressure	300 ... 1100 hPa	DMS bridge
T-Gas	0 ... 500 °C	NiCr/Ni
T-Air	0 ... 99 °C	Semi-conductor
Differential pressure	0 ... +/- 100 hPa	DMS bridge
Efficiency	0 ... 120 %	Calculation
Losses	0 ... 99,9 %	Calculation
Excess air	1 ... ∞	Calculation
Ref. O ₂ adjustable	0 ... 21 vol. %	Calculation
Taupunkt der Abgase		Calculation
Power supply	Mains power 230 V / 50 Hz~ Battery 7,2 V / 11,6 Ah	
Dim. (L x H x D)	525 mm x 845 mm x 270 mm	
Weight	approx. 34 kg with heated sampling system	
Application limits	+5 °C to +40 °C; max. 90 % RH, non-condensing	

Subject to technical changes
V3.85 / 09.2019

18. FAQ

Where do I find important instrument information?

In the menu „Control“ all important instrument information are shown (e.g. battery voltage, sensor values, unit number, next service date, operation hours etc.). With the arrow keys stands you can switch to the second page.

The instrument shows the error message „O₂ sensor 0 mV“!

The sensor must be renewed.

The instrument shows the message „Check required“!

This message appears automatically every 12 months. Note: This is a recommendation to let check the instrument. The instrument is however still ready for use.

The instrument shows the error message „T-Gas“ or „T-Air“!

Possible reasons could be:

- Cable is broken (at the plug)
- T-Air sensor is broken
- Thermocouple is broken
- Cable is defective

Note: The error messages can be ignored at the J2KN^{PRO} TECH by pressing „OK“. Calculations that depend on these temperatures are not implemented.

The instrument shows wrong or inaccurately CO₂ values!

Possible reasons could be:

- O₂ is defective (CO₂ values are calculated from the O₂ values)
- Pump is not working correctly
- Leakage in the gas way
- Condensate trap / gas cooler is clogged

My instrument cannot be switched on!

- Please check the mains cable
- Please check the fuse
- Please check mains connection (Plug socket switched on?)
- Please load the accumulator min. 8 hours (Accumulator could be over-discharged)

My instrument does not print!

Please check whether the printer paper is correctly inserted. The thermal printer writes only on the thermally sensitive side. Please use always the correct paper for the printer, you will prevent defects at the printer. Please make sure that the printer is clean (no chads in the drive).

Can I change the printout?

You can change the printout (Menu: Adjustments).

Hint: If you have several instruments of the same type, you can locate an error by exchanging the accessories (probe, hose, temperature sensor etc.).

If further questions or problems should arise, please contact the next authorised service centre.

Description of data record ecom-J2KN^{PRO} TECH with Multi Media Card

Format data logger records: J2KDL-xx.csv (separation mark between values = comma)

Format punctual measurements: J2KDV.txt (separation mark between values = comma)

Column	Description	Remark / Example
A	Date	DD.MM.YYYY (also US-Version)
B	Time	HH:MM:SS (also US-Version)
C	O ₂ in vol. %	0,0 - 21,0
D	CO in ppm	0 - 4000
E	NO in ppm	0 - 5000
F	NO ₂ in ppm	0 - 1000
G	SO ₂ in ppm	0 - 5000
H	CO converted*	
I	NO converted*	
J	NO ₂ converted*	
K	NO _x converted*	
L	SO ₂ converted*	
M	T.Gas in °C or °F	0 - 500 (US-Version with other range in °F)
N	T.Air in °C or °F	0 - 99 (US-Version with other range in °F)
O	Draught in hPa	0,00 - 20,00
P	CO ₂ in vol. %	0,0 - 25,0
Q	Efficiency in %	0,0 - 120,0
R	Losses in %	0,0 - 100,0
S	Excess air	> 1,00
T	Dew point in °C or °F	0 - 500 (US-Version with other range in °F)
U	Poisoning index	> 0,0
V	O ₂ (gas channel check) in vol. %	0,0 - 21,0
W	CO (gas channel check) in ppm	Related to 0,0 vol. % O ₂
X	CO (gas channel check) in ppm	Measured value
Y	O ₂ (O ₂ check) in vol. %	0,0 - 21,0
Z	T.Boiler	0 - 999
AA	T.Sensor	0 - 99
AB	O ₂ reference	0,0 - 21,0
AC	Unit	0=ppm; 1=mg/m ³ ; 2=mg/kWh; 3=mg/MJ
AD	Norm	N = converted to O ₂ ref.
AE	Fuel type number	Index acc. to instrument table
AF	Fuel type text	Text acc. to instrument table
AG	Soot 1	0,0 - 9,9
AH	Soot 1	0,0 - 9,9
AI	Soot 1	0,0 - 9,9
AJ	Oil trace	0=no; 1=yes;
AK	20 characters text	
AL	20 characters text	
AM	16 characters text	
AN	Serial number	
AO	CO (O ₂ check) in ppm	
AP	Zug (O ₂ check) in hPa	
AQ	CxHy	
AR	Number copy data	
AS	T1 (deltaT-measurement)	
AT	T2 (deltaT-measurement)	
AU	Velocity	m/s
AV	CO Environment	CH-version = Kind of control
AW	free	CH-version = Load range
AX	Comment text	
AY	Comment text	
AZ	Comment text	
BA	Comment text	
BB	H ₂ in ppm	CH version = Oil consumption
BC	H ₂ converted*	CH version = Thermal output
BD	Sensor 6 in ppm	CH version = Operation hours counter
BE	Sensor 6 converted *	CH version = Code
BF	dP (velocity) in Pa	0 – 1000,00

BG	Air pressure in hPa	300 – 1100
BH	Unit 2	0=ppm; 1=mg/m ³ ; 2=mg/kWh; 3=mg/MJ; 4=ppmN; 5=mg/m ³ ; 6=---
BI	CO (Unit 2)	
BJ	NO (Unit 2)	
BK	NO ₂ (Unit 2)	
BL	NO _x (Unit 2)	
BM	SO ₂ (Unit 2)	
BN	Analogue input 1	
BO	Analogue input 2	
BP	Sensor 7 in ppm	
BQ	Meas. gas volume in l/min	
BR	CO%	
BS	last column	0

* converted to unit (column AC) and converted on O₂ ref. (Column AB) when column AD = N

Data transfer ecom-J2KN^{PRO} TECH to PC (USB)

The transfer occurs with 1200 - 38400 BAUD; 1 stop bit; no parity (ANSI character set)
CR / LF is send after each data record

Column	Description	Length
1-5	Storage number	5
6-7	Hour	2
8-9	Minute	2
10-11	Day	2
12-13	Month	2
14	Fuel type number (0 – 9)	1
15-19	T.Air in °C or °F	5
20-24	T.Gas in °C or °F	5
25-29	O ₂ in vol.% (without comma)	5
30-34	CO in ppm	5
35	Draught (sign / - = minus; blank character = plus)	1
36-39	Draught in Pa	4
40	Oil trace (0 = no; 1 = yes)	1
41	Soot 3	1
42	Soot 2	1
43	Soot 1	1
44-48	free	5
49-53	NO in ppm	5
54-58	T.Boiler	5
59-78	20 character text (1st display line)	20
79-98	20 character text (2nd display line)	20
99-114	16 character text (3rd display line)	16
115-116	2 signs (HEX \$80, \$00)	2
117-121	O ₂ (CO measurement) in vol.% (without comma)	5
122-126	CO (CO measurement) in ppm related to 0,0 vol.% O ₂	5
127-131	free	5
132-136	free	5
137-141	free	5
142-146	free	5
147-151	free	5
152-156	O ₂ (O ₂ check) in vol.% (without comma)	5
157-161	CO (O ₂ check) in ppm	5
162	Draught (O ₂ check / sign / - = minus; blank character = plus)	1
163-166	Draught (O ₂ check) in Pa	4
167-168	CR-LF (#13#10)	2

Data transfer PC to ecom-J2KN^{PRO} TECH (ANSI character set):

First send: \$00 \$01
Then send: 56 characters text
Then send: \$80 \$00

Once the ecom-J2KN^{PRO} TECH has processed the data, it sends \$FF back. If the data volume is too large, it sends another byte back. If the data transfer should be terminated, so just 60 byte \$00 need to be sent to the instrument.

ecom GmbH

Am Großen Teich 2

D-58640 Iserlohn

Telefon: +49 (0) 23 71 - 9 45-5

Telefax: +49 (0) 23 71 - 4 03 05

Internet: <http://www.ecom.de>

eMail: info@ecom.de